

# 2018

AMERICAN SOCIETY OF CIVIL ENGINEERS®  
NATIONAL CONCRETE CANOE COMPETITION™

## RULES AND REGULATIONS



**ASCE**  
AMERICAN SOCIETY OF CIVIL ENGINEERS

**Date:** September 8, 2017  
**To:** ASCE Student Chapter and Concrete Canoe Teams  
**Subject:** Release of Rules & Regulations for 2018 ASCE  
National Concrete Canoe Competition

1801 Alexander Bell Drive Reston, VA 20191-4382  
(800) 548.2723 toll free (703) 295.6300 intl  
(866) 902.6249 fax ■ www.ASCE.org

Dear ASCE Student Chapter and Concrete Canoe Teams:

The Committee on National Concrete Canoe Competitions (CNCCC) is pleased to release the *Rules and Regulations* for the 2018 ASCE National Concrete Canoe Competition which will be hosted by San Diego State University, June 23-25, 2018!

The following documents are included as supplemental documents to the *Rules and Regulations* which can be found at the following link (<http://www.asce.org/rules-and-regulations/>)

- Competition Memorandum
- Acknowledgement Form
- ASCE NCCC Facebook Page Flyer
- Canoe Spirit Poster

The *Competition Memorandum* covers a wide range of topics which the CNCCC wishes to address including, proper referencing of documents in the design report, copyright infringement and theme selection, common errors on mixture design tables, and the “Spirit of the Competition.” The *Acknowledgement Form* requires each team to sign off and acknowledge the various requirements of ASCE Student Chapter eligibility, individual registered participant eligibility, and submissions for Conference and National Competitions including deadlines, formats and locations. **The form is due by November 1, 2017** (uploaded to the ASCE server). The *Facebook Page Flyer* directs the teams to our page (<https://www.facebook.com/ASCENCCC>) which is where all the responses to the Request for Information are posted, along with general announcements related to the competition.

*New this year*, in the spirit imparted by John R. Craig as he envisioned the National Concrete Canoe Competition in addition to the top qualified team from each Student Conference, up to six (6) teams, geographically disbursed, may also qualify to participate at the National Competition as a designated *Wildcard*. Specific details on the qualification and selection processes are detailed in the *Competition Memorandum* and the *Rules and Regulations*. We hope that this opportunity will allow more ASCE student chapters to experience the learning, teamwork, pride and fun involved while participating the National Competition.

We wish all the student chapters the best as you begin to formulate your mixture designs, construct hull designs, and manage a team of young, energetic engineering students! See you in San Diego!!

Sincerely,

**COMMITTEE ON NATIONAL CONCRETE CANOE COMPETITIONS**

*Candace S. Sulzbach*

Candace S. Sulzbach, P.E., F.ASCE  
Chair, CNCCC (2018)

## TABLE OF CONTENTS

INTRODUCTION .....	ii
AWARDS AND RECOGNITION.....	iii
ASCE NATIONAL CONCRETE CANOE COMPETITION™ SPONSORS.....	iv
PAST TOP FIVE FINISHERS AND HOST SCHOOLS.....	v
ASCE CORPORATE PROFILE .....	vii
R. JOHN CRAIG MEMORIAL AWARD .....	viii
Section 1 – GENERAL RULES AND ELIGIBILITY REQUIREMENTS.....	1
Section 2 – CANOE .....	6
Section 3 – CONCRETE .....	11
Section 4 – REINFORCEMENT .....	19
Section 5 – FINISHING .....	22
Section 6 – DESIGN PAPER .....	24
Section 7 – PROJECT OVERVIEW & TECHNICAL ADDENDUM.....	32
Section 8 – ORAL PRESENTATION.....	35
Section 9 – FINAL PRODUCT (Canoe and Cutaway Section) .....	36
Section 10 – PRODUCT DISPLAY .....	38
Section 11 – RACE RULES AND REGULATIONS.....	41
Section 12 – NATIONAL QUALIFYING RULES .....	49
Section 13 – OVERALL SCORING .....	50
Appendix A – Judges’ Score Sheets	
Design Paper Score Sheet .....	A-1
Oral Presentation Score Sheet .....	A-2
Final Product Aesthetics Score Card.....	A-3
Instructions - Deduction Score Cards .....	A-6
Design Paper Deduction Score Card.....	A-7
Final Product Deduction Score Card (Conference Level) .....	A-9
Final Product Deduction Score Card (National Level).....	A-11
Appendix B – Forms	
Repair Procedure Report.....	B-1
Reconstruction Request .....	B-2
Damage/Accident Report .....	B-3
Request for Clarification and Appeals Form (Conference Competition) .....	B-4
Request for Clarification and Appeals Form (National Competition) .....	B-5
Appendix C – General Guidelines for Concrete Mixture Data Table.....	C-1
Appendix D – Job Hazard Analysis Form.....	D-1

## INTRODUCTION

Since the early 1970s, ASCE student chapters have been constructing and racing concrete canoes. During that time, canoe mixes and designs have varied, but the long-established tradition of teamwork, camaraderie, and spirited competition has been constant. Teams, their associates, judges, and all other participants are expected to maintain and build upon this tradition.

The objectives of the National Competition are as follows:

- Providing civil engineering students an opportunity to gain hands-on, practical experience and leadership skills by working with concrete mix designs and project management.
- Building awareness of the versatility and durability of concrete as a construction material among civil engineering students, educators and practitioners, as well as the general public.
- Creating awareness of concrete technology and application among civil engineering students, educators and practitioners, as well as the general concrete industry.
- Generating and increasing awareness of ASCE's and national sponsors' commitment to civil engineering education among civil engineering students, educators and practitioners, and well as the general public.
- Increasing awareness among industry leaders, opinion makers and the general public of civil engineering as a dynamic and innovative profession essential to society.
- Increasing awareness of the value and benefits of ASCE membership among civil engineering students and faculty in order to foster lifelong membership and participation in the Society.

While the intent of the competition is to learn and build experience both technically and socially, students are a short step from being practicing engineers involved in projects that are critical to society's welfare. Ethics, professionalism, civility and respect are the cornerstone of every successful competition, and ASCE expects professional conduct from all participants. To preserve the quality of this competition and to improve the quality of future competitions, ASCE enforces high standards under the Section 1.9, "Spirit of the Competition."

The rules are divided into thirteen (13) sections plus several appendices; please review each section thoroughly.

**Good luck, have fun and be safe!**

## AWARDS AND RECOGNITION

The winners of the National Concrete Canoe Competition™ shall be determined by compiling a team's total number of points from the academic and race portions of the competition. ASCE shall award a total of \$9,000 in academic scholarships to the winning teams' undergraduate civil engineering program. To be eligible to receive a scholarship, the entrant school must be a recognized ASCE Student Organization.

The local ASCE Student Chapter shall determine selection of the academic scholarship winner(s). The academic scholarships shall be awarded to student member(s) within twelve (12) months of completion of the current years' national finals. The academic scholarship money shall be used toward satisfying tuition reimbursements only and shall not be used to fund current or future concrete canoe competitions. ASCE shall be notified in writing of academic scholarship winner(s) prior to distribution to recipients.

Total scholarship awards shall be distributed as follows:

1st place overall winner:	\$5,000 scholarship and trophy
2nd place overall winner:	\$2,500 scholarship and trophy
3rd place overall winner:	\$1,500 scholarship and trophy

Special plaques shall be awarded to the top team in the following individual categories:

4th place overall winner:	Commemorative Plaque
5th place overall winner:	Commemorative Plaque

Best Design Paper  
Best Oral Presentation  
Best Final Product  
Women's Endurance Race  
Men's Endurance Race  
Women's Sprint Race  
Men's Sprint Race  
Spirit of the Competition

A special plaque in honor of R. John Craig, a former ASCE Committee on Student Services member who was a driving force behind the National Concrete Canoe Competition, shall be awarded to the team that has the best time in the coed sprint race.

Appropriate awards shall be presented to teams finishing second through fifth in each event. Each team shall receive a commemorative plaque for their participation in the National Concrete Canoe Competition™. All ten (10) registered team members in the National Concrete Canoe Competition™ shall receive a certificate of participation for the National Competition.

**ASCE NATIONAL CONCRETE CANOE COMPETITION™ SPONSORS**

**THANK  
YOU**

**ASCE thanks the National Concrete Canoe Competition sponsors for their support in making the event possible.**

**If you are interested in becoming a sponsor of the 2018 ASCE National Concrete Canoe Competition™, please contact ASCE Sponsorship at (703)295-6000.**

## PAST TOP FIVE FINISHERS AND HOST SCHOOLS

2017 (Colorado School of Mines, Golden, CO)

1. California Polytechnic State University San Luis Obispo
2. University of Florida
3. University of Akron
4. Tongji University
5. École de technologie supérieure

2016 (University of Texas – Tyler)

1. École de technologie supérieure
2. University of California, Los Angeles
3. University of Nevada, Reno
4. Western Kentucky University
5. University of Wisconsin – Madison

2015 (Clemson University, Clemson, SC)

1. University of Florida
2. California Polytechnic State University San Luis Obispo
3. University of California, Berkeley
4. École de technologie supérieure
5. Clemson University

2014 (University of Pittsburgh-Johnstown, Johnstown, PA)

1. University of Nevada, Reno
2. California Polytechnic State University San Luis Obispo
3. Université Laval
4. Utah State University
5. University of Wisconsin – Madison

2013 (University of Illinois at Urbana-Champaign, Urbana, IL)

1. École de technologie supérieure
2. University of Nevada, Reno
3. University of Florida
4. California Polytechnic State University San Luis Obispo
5. Utah State University

2012 (University of Nevada, Reno, Reno, NV)

1. California Polytechnic State University San Luis Obispo
2. Université Laval
3. Michigan Technological University
4. University of Nevada, Reno
5. University of Florida

2011 (University of Evansville, Evansville, IN)

1. California Polytechnic State University San Luis Obispo
2. University of Wisconsin – Madison
3. Université Laval
4. California State Polytechnic University Pomona
5. University of Nevada, Reno

2010 (California Polytechnic State University San Luis Obispo, San Luis Obispo, CA)

1. California Polytechnic State University San Luis Obispo
2. University of Nevada, Reno
3. École de technologie supérieure
4. Michigan Technological University
5. University of Wisconsin – Madison

2009 (University of Alabama, Tuscaloosa, AL)

1. University of California – Berkeley
2. École de technologie supérieure
3. California Polytechnic State University San Luis Obispo
4. University of Florida
5. University of Nevada, Reno

2008 (École de technologie supérieure, Montréal, QC)

1. University of Nevada, Reno
2. University of California - Berkeley
3. École de technologie supérieure
4. California Polytechnic State University San Luis Obispo
5. University of Florida

2007 (University of Washington, Seattle, WA)

1. University of Wisconsin – Madison
2. University of Florida
3. University of Nevada, Reno
4. Western Kentucky University
5. California Polytechnic State University San Luis Obispo

2006 (Oklahoma State University, Stillwater, OK)

1. University of Wisconsin – Madison
2. California Polytechnic State University San Luis Obispo
3. Clemson University
4. University of California – Berkeley
5. Michigan Technological University

2005 (Clemson University, Clemson, SC)

1. University of Wisconsin – Madison
2. Clemson University
3. Michigan Technological University
4. University of California – Berkeley
5. United States Military Academy

2004 (ASCE & Catholic University, Washington, DC)

1. University of Wisconsin – Madison
2. Université Laval
3. University of Alabama in Huntsville
4. Clemson University
5. Milwaukee School of Engineering

---

2002 (University of Wisconsin – Madison, Madison, WI)	1995 (George Washington University, Washington, DC)
<ol style="list-style-type: none"> <li>1. Clemson University</li> <li>2. Université Laval</li> <li>3. Oklahoma State University</li> <li>4. Western Kentucky University</li> <li>5. University of Wisconsin – Madison</li> </ol>	<ol style="list-style-type: none"> <li>1. South Dakota School of Mines</li> <li>2. California State University at Sacramento</li> <li>3. Michigan State University</li> <li>4. Clemson University</li> <li>5. University of New Orleans</li> </ol>
2003 (Drexel University, Philadelphia, PA)	1994 (University of New Orleans, New Orleans, LA)
<ol style="list-style-type: none"> <li>1. University of Wisconsin – Madison</li> <li>2. Université Laval</li> <li>3. University of California – Berkeley</li> <li>4. Clemson University</li> <li>5. University of Oklahoma</li> </ol>	<ol style="list-style-type: none"> <li>1. University of Alabama in Huntsville</li> <li>2. University of California – Berkeley</li> <li>3. University of New Orleans</li> <li>4. South Dakota School of Mines and Technology</li> <li>5. Clemson University</li> </ol>
2001 (San Diego State University, San Diego, CA)	1993 (California State University – Sacramento, Sacramento, CA)
<ol style="list-style-type: none"> <li>1. University of Alabama in Huntsville</li> <li>2. Clemson University</li> <li>3. Oklahoma State University</li> <li>4. Université Laval</li> <li>5. South Dakota School of Mines and Technology</li> </ol>	<ol style="list-style-type: none"> <li>1. University of Alabama in Huntsville</li> <li>2. Michigan State University</li> <li>3. University of California – Berkeley</li> <li>4. University of New Orleans</li> <li>5. Colorado State University</li> </ol>
2000 (Colorado School of Mines, Golden, CO)	1992 (Colorado State University, Fort Collins, CO)
<ol style="list-style-type: none"> <li>1. Clemson University</li> <li>2. Oklahoma State University</li> <li>3. Florida Institute of Technology</li> <li>4. Michigan State University</li> <li>5. University of Washington</li> </ol>	<ol style="list-style-type: none"> <li>1. University of California – Berkeley</li> <li>2. University of Alabama in Huntsville</li> <li>3. University of New Orleans</li> <li>4. University of Maryland</li> <li>5. Michigan State University</li> </ol>
1999 (Florida Institute of Technology, Melbourne, FL)	1991 (University of Central Florida, Orlando, FL)
<ol style="list-style-type: none"> <li>1. Clemson University</li> <li>2. University of Alabama in Huntsville</li> <li>3. Oklahoma State University</li> <li>4. University of Washington</li> <li>5. South Dakota School of Mines and Technology</li> </ol>	<ol style="list-style-type: none"> <li>1. University of California – Berkeley</li> <li>2. University of Maryland</li> <li>3. State University of New York – Buffalo</li> <li>4. University of Illinois – Urbana/Champaign</li> <li>5. University of Texas – Austin</li> </ol>
1998 (South Dakota School of Mines and Technology, Rapid City, SD)	1990 (State University of New York – Buffalo, Buffalo, NY)
<ol style="list-style-type: none"> <li>1. University of Alabama in Huntsville</li> <li>2. California State University at Sacramento</li> <li>3. Clemson University</li> <li>4. Florida Institute of Technology</li> <li>5. University of Washington</li> </ol>	<ol style="list-style-type: none"> <li>1. Michigan State University</li> <li>2. University of Maryland</li> <li>3. University of California – Berkeley</li> <li>4. University of Texas – Austin</li> <li>5. University of Wisconsin – Milwaukee</li> </ol>
1997 (Cleveland State University, Cleveland, OH)	1989 (Texas Tech University, Lubbock, TX)
<ol style="list-style-type: none"> <li>1. Florida Institute of Technology</li> <li>2. University of Alabama in Huntsville</li> <li>3. University of California – Berkeley</li> <li>4. Michigan State University</li> <li>5. University of California – Los Angeles</li> </ol>	<ol style="list-style-type: none"> <li>1. University of California – Berkeley</li> <li>2. Michigan State University</li> <li>3. University of New Hampshire</li> <li>4. Washington State University</li> <li>5. University of Houston</li> </ol>
1996 (University of Wisconsin – Madison, Madison, WI)	1988 (Michigan State University, East Lansing, MI)
<ol style="list-style-type: none"> <li>1. University of Alabama in Huntsville</li> <li>2. Michigan State University</li> <li>3. University of California – Berkeley</li> <li>4. South Dakota School of Mines and Technology</li> <li>5. Clemson University</li> </ol>	<ol style="list-style-type: none"> <li>1. University of California – Berkeley</li> <li>2. University of New Hampshire</li> <li>3. University of Akron</li> <li>4. Portland State University</li> <li>5. University of Alabama in Huntsville</li> </ol>



## CORPORATE PROFILE

### American Society of Civil Engineers (ASCE)

The American Society of Civil Engineers (ASCE) is the oldest national engineering society in the United States. Founded in 1852 with 12 members, the Society was created to disseminate information among engineers who were building the roads, canals, bridges and railroads of a young nation.

Today, ASCE has more than 150,000 members, including some 15,000 of whom are international members residing outside the United States in 177 countries. Individual professional engineers rather than companies or organizations hold membership. The members are organized geographically into ten regions, 75 sections, 155 branches, 12 Younger Member Groups and 300+ student chapters and international student groups.

The objective of ASCE is to enhance the welfare of mankind through the advancement of the science and profession of engineering. In response to these goals, more than 6,200 members voluntarily serve nearly 600 different technical, administrative and coordinating committees. Another 300 participate on 36 other professional committees. Including the activities of sections, student chapters and international student groups, as well as the national and local committees, ASCE groups average 100 meetings throughout the country every day.

Educational activities extend to college campuses through more than 300 student organizations. These organizations sponsor meetings, educational outreach, conferences, student competitions, social events and other activities to help future engineers become better prepared for their careers. Numerous scholarships and awards are made available for deserving students of civil engineering.

A 17-member Board of Direction governs the Society. The Board, which includes ASCE officers and representatives elected by the membership, establishes all policy for the organization. A staff of 250 implements the policies; the vast majority of staff work at ASCE International Headquarters located in Reston, Virginia.

For more information, visit <http://www.asce.org>.



## R. JOHN CRAIG MEMORIAL AWARD

The concept of a National Concrete Canoe Competition™ had been around for a number of years. In the mid-1980s Dr. R. John Craig, a professor at the New Jersey Institute of Technology and member of the ASCE Committee on Student Services (CSS), and other members of CSS began to formulate plans for more uniform Regional Competitions and formalized a plan to study the feasibility of a National Competition.

In the spring of 1985 Dr. Craig first brought his grand vision of a National Concrete Canoe Competition™ to ASCE. He was instrumental in bringing delegates from all over the country to meet one auspicious day in New York City at the executive conference of the ASCE National Headquarters. During this meeting the feasibility of conducting a National Concrete Canoe Competition™ was discussed, preliminary rules prepared, and a formal recommendation to proceed was drafted.

In the fall of 1985 the preliminary rules were presented to the Committee on Student Services (CSS). During the next year discussions regarding sponsorship were conducted with Master Builders, Inc. and ASCE Headquarters. After almost two years of committee debate, while meeting at the fall 1987 ASCE National Convention the Educational Activities Committee (EdAC) adopted the preliminary rules and established a standing task committee to implement the rules and requirements.

In the winter of 1987, just as the first National Competition was in sight, Dr. Craig was diagnosed with a rare inoperable brain tumor. He passed away just two months before his dream of a National Concrete Canoe Competition came to fruition. In June of 1988 the first National Competition was held in East Lansing, Michigan hosted by Michigan State University.

In the spring of 1989, CSS approved the formation of a permanent subcommittee to ensure the execution of the National Concrete Canoe Competition. Through the efforts and dedication of individuals like Dr. R. John Craig their efforts have established this National Concrete Canoe Competition™.

In that spirit ASCE has dedicated the Coed Sprint Race as a memorial to the teamwork and dedication of Dr. R. John Craig. It is our distinct honor to present the *R. John Craig Memorial Award* to the school that best exemplifies the spirit and cooperative ideals of the Competition by placing first in the Coed Sprint Race each year.

## Section 1 – GENERAL RULES AND ELIGIBILITY REQUIREMENTS

### 1.0 RULE CHANGES AND PRECEDENCE

The Rules and Regulations (Rules) of the National Concrete Canoe Competition™ (National Competition) are updated each year. **Teams are strongly encouraged to read this document carefully and disregard previous editions.** Teams should not consider items such as rulings and interpretations made by judges in previous competitions and answers provided in previous *Request for Information (RFI) Summaries*, as setting precedence for this year's competition.

### 1.1 QUALIFIERS

Teams may be invited to the National Competition by placing as the top qualified team at one of the nineteen (19) ASCE Student Conference Concrete Canoe Competitions (Conference Competitions), as the host school of the National Competition, or as a designated Wildcard. All qualifying teams must represent an ASCE Student Chapter. The National host school has the choice of competing in the current year or deferring their entry until the following year. The National host school must compete at their respective Conference Competition the same year they intend to compete in the National Competition.

Conference level competitions are required to meet certain standards. To earn an invitation to the National Competition, a student team shall qualify through participation in its assigned Conference Competition. There must be at least three (3) eligible ASCE Student Chapters that are official members of the Conference participating in the concrete canoe competition to constitute a qualified Conference Competition. In addition, the Conference Competition must be hosted by a school that is an official member of the Conference. Only one (1) team from any given school can compete in a Conference Competition.

#### 1.1.1 Wildcard Teams

In addition to the top qualified team from each Student Conference, up to six (6) teams, geographically disbursed, may also qualify to participate at the National Competition as a designated Wildcard. Wildcard teams must:

- Score in the top one-third (1/3) of all Annual Student Chapter Reports,
- Respond to a notice from ASCE with a Statement of Interest, and
- Finish overall within the top half (1/2) of their respective Conference Competition.

All student chapters that place within the top one-third (1/3) of all Annual Reports will receive an email notice immediately after the reports are scored. The notice will ask teams to respond with a Statement of Interest within two (2) weeks of receipt, including a letter of support from their Department Chair and ASCE Chapter Faculty Advisor. After all student conferences are complete, all teams that placed in the top half (1/2) of their respective competitions will be cross referenced with those that submitted a statement of interest. From that group, up to six (6) teams will be selected randomly to be invited to the National Competition. A given conference cannot have more than one (1) Wildcard team selected in a given year.

#### 1.1.2 Student Chapter Eligibility for National Competitions

To facilitate broader participation by ASCE Student Chapters in Student Conference activities, ASCE Headquarters stresses the importance of the Student Conference as an event that is much more than a qualifying round for national competitions. As such, all ASCE Student Chapters must

meet the following eligibility requirements to participate in an ASCE-sponsored national competition:

1. Be in good standing with ASCE:
  - a. Have submitted their Annual Report and paid their annual dues, as received by ASCE, prior to the start of the Student Conference; and
  - b. FOR CONCRETE CANOE ONLY – Have submitted their student chapter full Annual Report in time to be graded (reports submitted on or before February 1, 2018 meet this qualification), and have scored within the top two-thirds (2/3) of all student chapters. **Student Chapters that submit an EZ annual reporting form do not qualify**; and
  - b. Act appropriately. As representatives of ASCE and the civil engineering profession, all competition and conference participants are expected to and must act professionally and courteously. The use of alcohol, marijuana, or other controlled substance is strictly prohibited.

*Note: Invitations to Conference and National Competitions are a privilege, not a right. Failure to act appropriately can result in letters of reprimand, mandatory behavior management plans, and loss of invitations to further competition for individual institutions and/or entire conferences.*

2. Attend and participate in their assigned Student Conference as shown through their school's:
  - a. Good faith participation in the Student Conference Business Meeting (at least one (1) student representative present at the **start** of the Business Meeting);
  - b. Good faith participation in the Student Conference Paper Competition, including submission and presentation by at least one (1) member of the ASCE Student Chapter, not necessarily a member of the concrete canoe team; Note that the concrete canoe design paper/oral presentation does not count as an entry into the Student Conference Paper Competition; and
  - c. Meeting any additional requirements of Student Conference participation set by the Student Conference at the previous year's business meeting or in their written and approved by-laws, standing rules, or constitution.

## 1.2 REGISTERED PARTICIPANTS

A team may register a maximum of five (5) male and five (5) female participants. Teams may have less than ten (10) registered participants. Registered participants are eligible to present at the Oral Presentation and/or compete in the races. Substitutions will be allowed up to the time of on-site registration. No substitutions shall be permitted after on-site registration has been completed. Each team shall designate two (2) registered participants as team captains.

### 1.2.1 Eligibility Requirements

Registered participants shall meet all the following requirements:

- a. Be an undergraduate student majoring in engineering or engineering technology during the 2017/18 academic year (August 2017 to June 2018). Students do not need

to be enrolled during the entire year (e.g., students graduating in December, or students not in school during the fall term but in school for the spring term.) Students that graduate during the academic year and have begun graduate studies during the same academic year are eligible to compete;

- b. Be members of an ASCE Student Organization in good standing (Section 1.1.2);
- c. Be National Student Members of ASCE. ASCE student membership numbers shall be required upon registration; and
- d. Have contributed to the design and construction of the concrete canoe during the current academic year.

### 1.2.2 Term Limits

Registered participation shall not exceed three (3) years (consecutive or non-consecutive). There are no term limits for participation in other supportive roles. “Registered participant” is defined as being an official team member that presents and/or paddles during a Conference or National Competition. There is no limit to the number of support personnel permitted to prepare the Final Product, Design Paper, Oral Presentation, and assist at the races. All students, both undergraduate and graduate, are strongly encouraged to actively participate in their school’s canoe project (concrete and materials design, canoe construction, design paper, fundraising, oral presentation preparation, etc.), including support at the Competitions.

## 1.3 PUBLICITY

For publicity purposes, ASCE may use any or all canoes and papers entered in the National Competition for a period of one (1) year from the date of the competition. All associated transportation costs, etc. shall be paid by ASCE.

## 1.4 SPONSORSHIP

The use of trade and company names for services, products, and intellectual property is permitted in the Design Report, Oral Presentation and Product Display for informational purposes only. Sponsorship recognition is limited to T-shirts and other apparel, or other non-competition related material. Sponsors are not to be recognized in the Oral Presentation (Section 8) or on the Product Display (Section 10).

## 1.5 ETHICS AND THE COMPETITION

According to the *ASCE Code of Ethics*, Canon 5, “Engineers shall build their professional reputation on the merit of their services and shall not compete unfairly with others.”

In the context of this contest, “unfair competition” may include conduct such as the following:

1. Failure to provide proper credit for past teams, plagiarism, or any other false statements concerning the source of material used in the contest;
2. Taking other people’s designs, artwork, or other creative content without permission (for an overview of Intellectual Property Laws, including Trademark and Copyright, visit <http://fairuse.stanford.edu/overview/introduction/intellectual-property-laws/>); and
3. Any false or malicious statements about other teams, members, or others involved in the contest.

## 1.6 REQUESTS FOR INFORMATION (RFI)

*Requests for Information* (RFI) are to be directed via e-mail to the Committee on National Concrete Canoe Competitions (CNCCC) at [cnccc@asce.org](mailto:cnccc@asce.org). Official responses will be posted to the CNCCC Facebook page (<https://www.facebook.com/ASCENCCC>). **The cut-off date for submitting a RFI is Monday, January 15, 2018.** Those received after this date will not be acknowledged or addressed. RFIs will be compiled and published in a RFI summary on or about February 1, 2018. **Teams are strongly encouraged to contact the CNCCC to avoid misinterpretation of rules at the Competitions. All RFIs will be made public.** Teams are also responsible for all information provided in the Rules and Regulations, the general questions and answers posted to the Facebook Page, and information given at competitions from the date of the release of the information.

## 1.7 GENERAL INFORMATION

General information on the competition as well as registration information for the National Competition is located on the ASCE website ([www.asce.org/concretecanoe](http://www.asce.org/concretecanoe)). Students shall be responsible for registration materials, Design Paper and *Project Overview and Technical Addendum* submittal deadlines published on these websites. Questions regarding National Competition qualifying procedures, etc. should be directed to the Student Services Department of ASCE via e-mail ([student@asce.org](mailto:student@asce.org)) or phone 1-800-548-ASCE or 703-295-6105.

## 1.8 SPIRIT OF THE COMPETITION

The judges and/or the CNCCC may take disciplinary action, including warnings, point deductions, or disqualification of a team or entry for inappropriate use of materials, language, alcohol, uncooperativeness, or general unprofessional behavior or unethical behavior of team members or persons associated with a team. The judges and/or the CNCCC have the final authority to determine what constitutes a violation of the “Spirit of the Competition” and may take appropriate action towards point deduction or disqualification.

## 1.9 APPEALS AND FINAL SCORE VALIDATION

### 1.9.1 Conference Competition

Appeals shall be filed by the designated team captains using the *Request for Clarification and Appeals Form* (Appendix B-4). The judges will resolve any appeals and may contact the CNCCC directly for assistance. All appeals shall be resolved before the Awards Ceremony. Judges’ original score sheets and final electronic score sheets shall be officially ratified by the Head Judge before the Awards Ceremony.

### 1.9.2 National Competition

Appeals shall be filed by the designated team captains using the *Request for Clarification and Appeals Form* (Appendix B-5). The judges will resolve any appeals with direct assistance from the CNCCC. All appeals shall be resolved before the Awards Ceremony. Judges’ original score sheets and final electronic score sheets will be officially ratified by the Head Judge and the CNCCC before the Awards Ceremony.

## 1.10 CANOE REMOVAL

It is the responsibility of the participating schools to remove their entire canoe and any associated debris from the host school site after the competition. The host school has the option to remove any remaining canoe debris from the site and bill the responsible school.

## 1.11 SAFETY

It is the responsibility of all participants to be knowledgeable of Occupational Safety and Health Administration (OSHA, [www.osha.gov](http://www.osha.gov)) policies. It is the responsibility of all participants to know about the materials that they are working with (See “Laboratories” and “Hazard Communication” Safety and Health Topics). Participants should obtain and read Safety Data Sheets (SDS) for each material they will be working with. It is the responsibility of all participants to work in a safe manner in a safe workplace environment. (See “Construction: Concrete and Masonry,” “Personal Protective Equipment,” and “Ventilation” Safety and Health Topics). Also, consult the “Silicosis Fact Sheet for Construction Workers” at [www.osha.gov](http://www.osha.gov))

Refer to Section 11 – RACE RULES AND REGULATIONS, in particular, Section 11.2, “Safety”, in regard to safety on the water.

## 1.12 SCHEDULE, DEADLINES, AND SUBMISSIONS

The following is a list of important dates related to overall competition schedule including deadlines of applicable submissions. Teams should consider this as only a partial list of dates (especially since Student Conference deadlines are not included in this list).

Item	Date
Issuance of 2018 Rules & Regulations	On or about September 8, 2017
“Fundamentals of Project Scheduling and the Critical Path Method” ASCE Webinar	October 4, 2017; 2 p.m. Eastern.
Deadline for Submission of <i>Preliminary Project Schedule and Acknowledgement Form (uploaded to ASCE server)</i>	November 1, 2017; 11:59 p.m. Eastern
Last Day to Submit RFI to CNCCC	January 15, 2018
Last Day to Submit ASCE Student Chapter Annual Reports	February 1, 2018
Issuance of RFI Summary	On or about February 1, 2018
ASCE Student Conference Competitions <i>(submission deadlines to be set by Conference Host School; electronic copies of Design Paper and Project Overview &amp; Technical Addendum to ASCE server coincide with those deadlines)</i>	Early March to Early May 2018
Submission of Design Papers for National Competition <i>(hard copies to ASCE <b>AND</b> uploading of Design Paper and Project Overview &amp; Technical Addendum to ASCE server)</i>	May 24, 2018; 5:00 p.m. Eastern
2018 ASCE National Concrete Canoe Competition, hosted by San Diego State University, San Diego, CA	June 23-25, 2018

## Section 2 – CANOE

**CNCCC Intent** – The intent of this section is to provide the specifications for the canoe to be built. In general, teams are to construct a canoe that (a) can withstand the rigors of competition including the transportation to and from the Conference and National Competitions, (b) are constructed of materials that are in strict compliance with these Rules and Regulations, (c) has been built within the current academic year and constructed and finished by the students, and (d) passes the flotation test to the satisfaction of the judges and/or CNCCC.

### 2.0 GENERAL

The term “canoe” is defined as any watercraft designed for paddlers using single-bladed paddles. Since the same canoe shall be used at both the Conference and National Competitions, it needs to be durable enough to perform in both events, including transportation to and from the contests. The canoe shall be built within the current academic year. Canoes shall be constructed and finished by the students themselves. “Construction” relates to the placement of concrete, reinforcement and flotation materials; “finishing” relates to sanding, sealing and application of letters. The fabrication of the canoe mold and lettering created with assistance from outside vendors are permitted.

Canoes are subject to an official weigh-in at the National Competition only (Appendix A-8) with the measured weight compared to the weight reported on the Compliance Certificate.

### 2.1 DIMENSIONAL CONSTRAINTS

#### 2.1.1 Length

The length of the canoe, defined as the maximum end-to-end (bow to stern) measurement considering the outermost longitudinal dimension of the hull, is restricted to 22 feet.

#### 2.1.2 Beam Width

The maximum width of the canoe, defined as the outermost lateral dimension of the hull, is restricted to 36 inches (see Figure 2.1). The location of the maximum width is at the discretion of the team.

#### 2.1.3 Other Dimensions

The dimensions for other canoe parameters such as, but not limited to, depth, hull thickness, radii of chines and rocker, are not regulated and their values are at the sole discretion of the team.

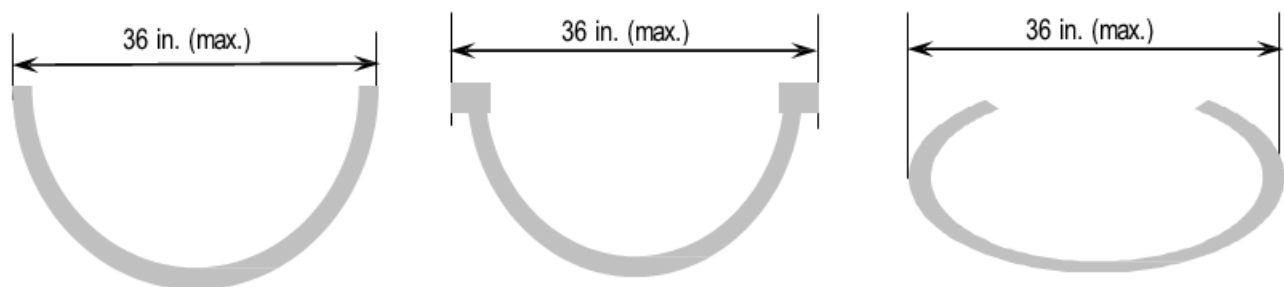

**Figure 2.1 – Definition of Maximum Width Measurement (Not to Scale)**



## **2.2 CONCRETE AND REINFORCEMENT**

Concrete mixtures shall comply with all specifications of Section 3 – CONCRETE. Materials not constituting part of a concrete mixture, except for those used for flotation, shall be classified as a reinforcing material and comply with all specifications of Section 4 – REINFORCEMENT.

## **2.3 STRUCTURAL ELEMENTS**

Structural elements such as ribs, gunwales, thwarts, and bulkheads are permitted if they do not impede paddlers from safely exiting the canoe. All canoe components, external protrusions, and structural elements shall be made of materials in full compliance with Section 3 – CONCRETE and Section 4 – REINFORCEMENT. Any reinforcement used must comply with thickness (Section 4.3.1) and percent open area (Section 4.3.2) requirements.

## **2.4 PADDLER RESTRAINTS**

Fixed paddler restraints, such as straps, seatbelts, Velcro®, suction cups or any other item that attaches the paddler to the canoe or that interferes with the paddler safely exiting the canoe in the event of capsizing, are not permitted. The judges and/or CNCCC will prohibit the use of any paddler restraints if safety is deemed an issue.

## **2.5 PADDLES**

Paddles shall be single-bladed and may be straight bladed or bent. Spare paddles are permitted in the canoe during the races.

## **2.6 SEATS AND MATS**

Dimensions of seats and mats are regulated to prevent them from serving as a structural component in the canoe. Seats cannot exceed a 20" x 20" x 20" maximum. Mats cannot exceed a 20" x 30" x ½" thick maximum. Seats and mats cannot be used together, at the same time, by one paddler. Each paddler may use either a seat or a mat as described above, but not both. The paddlers do not have to use the same types of seats or mats when paddling in the same race (for example, the seats may be of different dimensions; or one paddler uses a seat and another uses a mat). The seats and/or mats must be available for review by the judges in the configuration that they will be used during Final Product judging.

## **2.7 SLIP RESISTANT MATERIAL**

Use of non-skid tape or other slip resistant material is not permitted to be adhered to the canoe. Paddlers are permitted to wearing protective gear such as knee pads, such that it does not conflict with Section 2.4.

## **2.8 SPRAY SKIRTS**

Post-construction applied devices that prevent water from entering the canoe, such as spray skirts, are not permitted.

## **2.9 GUNWALE**

The gunwale shall be finished in such a way as to prevent injury to the paddlers (i.e., no exposed reinforcement or sharp edges). Gunwale caps or coverings that are not cast as an integral part of the original canoe shall not introduce a structural element to the canoe. Exterior gunwale caps that could provide rigidity (e.g., wood strips, plastic channels, or other rigid materials) shall be cut

into sections no longer than two (2) feet each. No rigid gunwale protection shall be permitted within two (2) feet of either the bow or stern ends of the canoe (Figure 2.2). Typical pipe insulation foam used as gunwale protection shall be permitted, is not considered as providing rigidity, and is not limited to the above constraint.

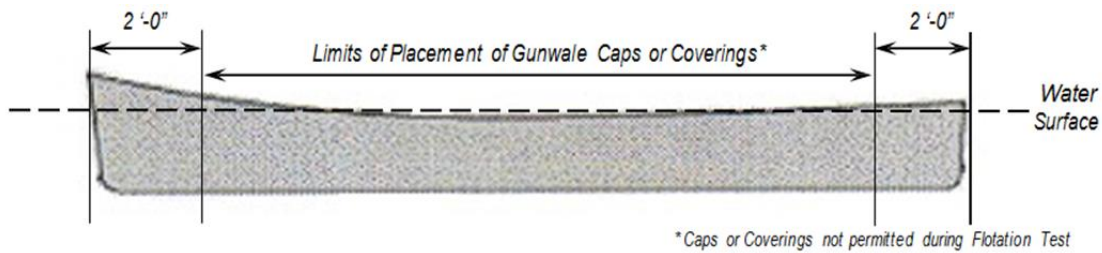

**Figure 2.2 – Limits of Rigid Gunwale Protection (Not to Scale)**

## 2.10 FLOTATION

### 2.10.1 Requirements

Canoes are to be able to pass the flotation test by the buoyant design of the canoe. No hollow cavities or air bladders are permitted. Flotation material shall be solid blocks of material. Particulate material (such as foam peanuts, sawdust, and similar products) is not permitted. Flotation shall be limited to within 3 feet of the bow and stern sections. **All flotation material incorporated into the canoe must be encased in concrete.** The only exception is flotation material that is added to a canoe that does not pass the flotation test (Section 2.10.3)

Gunwale caps or coverings (Section 2.9) are not permitted on the canoe during the flotation test. Once the canoe has been certified as passing, gunwale caps and covers may then be added.

### 2.10.2 Flotation Test

The canoe shall pass a flotation test whereby the canoe floats horizontally, with the canoe floating level at the water surface, within two (2) minutes of being filled with water.

Teams will have a maximum of ten (10) minutes to fully submerge and remove their canoe from the flotation tank or body of water where testing is being conducted. Teams are encouraged to bring their own supplies (i.e., buckets) to ensure that their canoe can be submerged and removed within the required time. Teams shall submerge their canoe by whatever means necessary (such as, filling the canoe with buckets of water, tilting the canoe so that water fills in, pushing it downward, etc.) and are solely responsible for handling the canoe to meet the requirements of the test.

A canoe shall be deemed as successfully passing the test if it floats level at the surface of the water without sinking once completely submerged. The canoe shall be certified as safe before entering any race, to the satisfaction of the judges and/or the CNCCC. **Canoes that do not pass the flotation test on the first attempt will automatically be assessed a 25-point deduction on the Final Product.**

### 2.10.3 Additional Flotation

If a canoe does not pass the flotation test, teams shall be required to add additional flotation materials until the canoe does pass the test to the satisfaction of the judges and/or the CNCCC. Any additional flotation that is applied (including the materials used to attach it, i.e., tape) must be secured to the inside of the canoe and must be below the gunwale line (Figure 2.3). No flotation

material shall be permitted on the top of the bow and stern sections. Gunwale caps and coverings shall not be permitted to serve as flotation material (Section 2.10.1).

Flotation added at the Conference Competition shall remain in place for canoes that qualify for the National Competition. At the National Competition, the canoe with its added flotation shall be considered “as built, as delivered” and shall be judged accordingly.

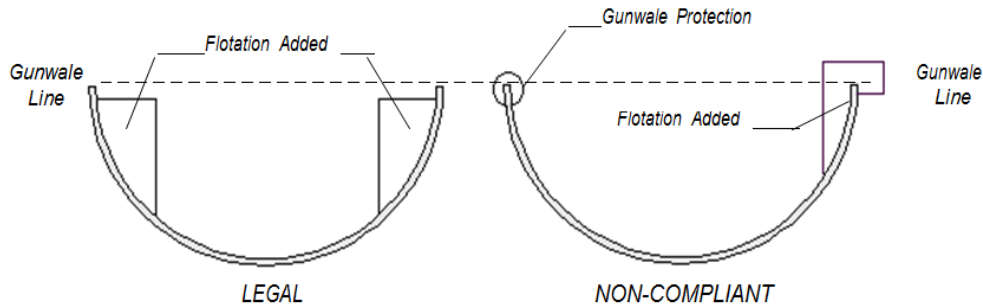

**Figure 2.3 – Examples of Additional Flotation to Pass Flotation Test**

## 2.11 REPAIRS

### 2.11.1 Repairs Made During Competition

During the competitions, inclusive of all events and transportation to and from, repairs can be made only with tape. Any type of tape is allowed. Canoes shall be assessed a deduction only if the tape is used because of a durability issue. If the damage resulted from a collision, deductions for a tape repair will not be assessed.

For each instance that tape must be applied to repair damage to a canoe, the team must first file a *Damage/Accident Report* (Appendix B-3) with the judges and/or the CNCCC and must receive written approval before any tape can be applied to the canoe.

### 2.11.2 Repairs Made Between Competitions

Repairs made to the canoe or the construction of a new canoe is subject to the requirements of Section 2.11.4, “Repair Procedure Report and Reconstruction Request.” Refinishing of the canoe (such as, but not limited to, additional sanding, repairing minor dent and cracks, and the reapplication of sealers) constitutes a repair and is subject to this section. The reapplication of letters is not considered to be a repair. Any proposed repairs shall be made using allowable materials as defined in Section 2.11.3, “Repair Materials,” and are subject to review by the CNCCC. If reconstruction is granted, the canoe shall be of the same hull design, materials and concrete mixture proportions, of the original canoe.

### 2.11.3 Repair Materials

Pre-packaged or pre-mixed concrete, mortar, or grout is not permitted in the construction or repair of the canoe. Bondo®, epoxy, or similar materials are not permitted as patching or filler material at any time during the construction of the canoe, as a legal repair material during the Competitions, or as a repair material between Competitions.

Concrete and reinforcing materials used for repairs of the canoe between the Conference and National Competitions shall meet the requirements of Section 2.11.4, “Repair Procedure Report and Reconstruction Request,” Section 3 – CONCRETE and Section 4 – REINFORCEMENT.

#### 2.11.4 Repair Procedure Report and Reconstruction Request

If the qualifying canoe is damaged during the Conference Competition or between the Conference and National Competitions, the team may patch, repair, and refinish it following the submission and subsequent approval of a *Repair Procedures Report*. If the damage is deemed beyond repair, the team shall submit a *Reconstruction Request* to the CNCCC to rebuild the canoe.

The *Repair Procedures Report* or *Reconstruction Request* must be formally requested from the CNCCC via e-mail at [cnccc@asce.org](mailto:cnccc@asce.org), completed and signed by the team captain(s) and ASCE Student Chapter Faculty Advisor, and received by the CNCCC within five (5) business days following the completion of the Conference Competition or the date that an incident damaging the canoe occurred.

The *Repair Procedure Report* or *Reconstruction Request* must contain sufficient information regarding the cause and extent of damage and the proposed repairs (including, the methodology, repair materials, and area of damage) to enable the CNCCC to decide regarding the approval of repairs or granting permission to rebuild a canoe. The CNCCC will review the *Repair Procedure Report* or *Reconstruction Request* and, if necessary, provide comments regarding the legality and suitability of the repairs. The catastrophic damage to the canoe resulting in a request to reconstruct, shall result in a thorough review of the durability and design of the canoe. Teams may be required to resubmit their *Repair Procedure Report* or *Reconstruction Request* based on the comments provided. Schools are not to repair or reconstruct their canoe until written approval is granted by the CNCCC.

If the CNCCC does not permit the team to repair the canoe, the team shall be given an opportunity to decide whether it can safely, and in “good faith”, compete at the National Competition with a non-repaired canoe. If this requirement is not possible, the Student Organization shall forfeit to the designated alternate Student Organization concrete canoe team within their Conference.

If it is determined by the CNCCC, poor design resulted in the damage to the canoe, the *Reconstruction Request* will be denied and the next Conference qualifying team will be invited to the National Competition. If it is determined the canoe may be re-built, the canoe shall be of the same hull design, materials, and concrete mix design of the original canoe. If this requirement is not possible, the team shall forfeit to the designated alternate concrete canoe team within their Conference.

**Schools granted permission to repair their canoes shall be assessed a 25-point deduction at the National Competition. Schools granted permission to reconstruct shall be assessed a 50-point deduction at the National Competition.** The CNCCC reserves the right to waive the automatic deductions that may be assessed on a case-by-case basis.

## Section 3 – CONCRETE

**CNCCC Intent** – The intent of this section is to provide the specifications for the various concrete mixtures that teams may proportion for their concrete canoe.

### 3.0 GENERAL

Each of the concrete mixtures should be considered as unique and independent mixtures and shall comply with all the requirements of this section. The use of pre-packaged or pre-mixed concrete, mortar, or grout is not permitted. Bondo®, epoxy or similar materials are not permitted during any stages of the construction of the canoe (i.e., as the component of the mixture itself, as an aid during the placement of concrete, as a modifier of the reinforcement, or as a means of attaching the flotation material). Mixtures used as filler and patching materials including repairs of any defects generated during the initial construction (such as cracks, “bug holes,” low spots, etc.) shall meet all the requirements of this section.

### 3.1 REFERENCES

The publications listed below form part of this specification to the extent referenced. The latest version of each standard shall govern wherever referenced. The publications are referred to in the text by basic designation only.

ASTM C39/C39M	Standard Test Method for Compressive Strength of Cylindrical Concrete Specimens
ASTM C109	Standard Test Method for Compressive Strength of Hydraulic Cement Mortars (Using 2 in. or [50 mm] Cube Specimens)
ASTM C125	Standard Terminology Relating to Concrete and Concrete Aggregates
ASTM C127	Standard Test Method for Density, Relative Density (Specific Gravity) and Absorption of Coarse Aggregates
ASTM C128	Standard Test Method for Density, Relative Density (Specific Gravity), and Absorption of Fine Aggregates
ASTM C138/C138M	Standard Test Method for Density (Unit Weight), Yield, and Air Content (Gravimetric) of Concrete
ASTM C150	Standard Specification for Portland Cement
ASTM C207	Standard Specification for Hydrated Lime for Masonry Purposes
ASTM C260	Standard Specifications for Air-Entraining Admixtures for Concrete
ASTM C309	Standard Specification for Liquid Membrane-Forming Compounds for Curing Concrete
ASTM C330	Standard Specification for Lightweight Aggregates for Structural Concrete
ASTM C494/C494M	Standard Specification for Chemical Admixtures for Concrete

ASTM C496/C496M	Standard Test Method for Splitting Tensile Strength of Cylindrical Concrete Specimens
ASTM C595	Standard Specifications for Blended Hydraulic Cements
ASTM C618	Standard Specifications for Coal Fly Ash and Raw or Calcined Natural Pozzolan for Use in Concrete
ASTM C979	Specifications for Pigments for Integrally Colored Concrete
ASTM C989	Standard Specification for Slag Cement for Use in Concrete and Mortars
ASTM C1059	Standard Specification for Latex Agents for Bonding Fresh to Hardened Concrete
ASTM C1116	Standard Specification for Fiber-Reinforced Concrete and Shotcrete
ASTM C1157	Standard Performance Specification for Hydraulic Cement
ASTM C1240	Standard Specification for Silica Fume in Cementitious Mixtures
ASTM C1315	Standard Specification for Liquid Membrane-Forming Compounds Having Special Properties for Curing and Sealing Concrete
ASTM C1438	Standard Specification for Latex and Powder Polymer Modifiers for Use In Hydraulic Cement Concrete and Mortar

## 3.2 MATERIALS

### 3.2.1 Cementitious Materials

#### 3.2.1.1 Hydraulic Cement

Shall meet the requirements of ASTM C150, ASTM C595 and/or ASTM C1157, and shall react with water to form a binder.

#### 3.2.1.2 Fly Ash

Shall meet the requirements of ASTM C618, Class C or Class F material.

#### 3.2.1.3 Metakaolin

Shall meet the requirements of ASTM C618, Class N.

#### 3.2.1.4 Slag Cement

Shall meet the requirements of ASTM C989, Grade 100 minimum

#### 3.2.1.5 Silica Fume

Shall meet the requirements of ASTM C1240.

### 3.2.1.6 Hydrated Lime

Shall meet the requirements of ASTM C207, Type S or N.

### 3.2.1.7 Other Cementitious Materials

Other secondary cementitious materials and pozzolans, such as but not limited to vitreous calcium aluminosilicate (VCAS™), are permitted. Teams wishing to incorporate a given material as a cementitious material/pozzolan and having questions or concerns of whether it is an acceptable material shall contact the CNCCC via e-mail for a determination of its applicability.

## 3.2.2 Fibers

Shall meet the requirements of ASTM C1116 and be dispersed within the concrete matrix.

## 3.2.3 Admixtures

### 3.2.3.1 Water-Reducing and Set-Controlling Admixtures

Shall meet the requirements of ASTM C494.

### 3.2.3.2 Air-Entraining Admixtures

Shall meet the requirements of ASTM C260.

### 3.2.3.3 Coloring Admixtures/Agents and Concrete Pigments

Shall meet the requirements of ASTM C979.

### 3.2.3.4 Polymer Modifiers, Bonding Adhesives, and Waste Latex Paints

Polymer modifiers shall be a latex or re-dispersible powder formulated for use with hydraulic cements that meets the requirements of ASTM C1438, Type II and accounted for in the mass and volume calculations during mixture proportioning to ensure proper yielding of the concrete mixtures.

Bonding adhesives (ASTM C1059), formulated for bonding old and new concrete, and waste latex paints are strictly prohibited and may not be used as an alternative polymer modifier.

### 3.2.3.5 Specialty Admixtures

Specialty admixtures, such as but not limited to, shrinkage reducers and viscosity-modifying admixtures, fall under ASTM C494 Type S, Specific Performance Admixtures and thus shall meet the requirements of this specification.

Epoxy resins, their curing agents, asphalt emulsions, or similar materials shall not be considered specialty admixtures and are strictly prohibited. Teams wishing to incorporate a material as a specialty admixture that does not fall under ASTM C494 Type S, is not commercially-available or specifically made for use in concrete and have questions or concerns of whether it is an acceptable material shall contact the CNCCC for a determination of its applicability.

### 3.3 REQUIREMENTS

#### 3.3.1 Number of Concrete Mixtures

Teams are limited to a total of three (3) concrete mixture designs. Any given mixture can be produced in multitude of colors if color is the only thing that changes. The amount of color admixture or pigment can vary from mixture to mixture.

#### 3.3.2 Type and the Amount of Cementitious Materials

Concrete can be prepared using any type of non-organic, cementitious binder. The binder could be either hydraulic, non-hydraulic, or a combination of these. Any hydraulic cement used, must meet the requirements of Section 3.2.1.1. If the binder contains commercially available non-hydraulic cement, include relevant Material Technical Data Sheets (MTDS) in the *Project Overview and Technical Addendum* (see Section 3.4.3.). If custom-made (non-commercial) products are considered, approval by the CNCCC shall be first obtained prior to its use.

#### 3.3.3 Aggregate Proportioning

Aggregates shall meet the following requirements for each individual concrete mixture [based on final yielded proportions]:

- a. Total aggregate volume, regardless of source, shall constitute 25% (min.) of the total volume of any concrete mixture;
- b. Of the total aggregate volume, a minimum of 25% of its volume, must be a commercially-available lightweight aggregate that is:
  - 1) Certified\* as meeting the specifications of ASTM C330, including aggregate type, chemical composition, physical properties, and testing of concrete samples for compressive and tensile strength, drying shrinkage, pop-outs, and resistance to freezing and thawing.
    - i. The certification must show/indicate that the grading of the aggregate(s) tested met one of those outlined in *Table 1 – Grading Requirements for Lightweight Aggregates for Structural Concrete* of ASTM C330.
    - ii. Teams are permitted to modify the particle size distribution (gradation) of the certified aggregate themselves and make it different than that given in the ASTM C330 requirements (for example, by taking the smaller sized portion of the overall gradation).
    - iii. Teams may secure from the supplier/manufacturer, aggregates classified as “fines” which cannot be tested per ASTM C330, if the base product from which they are produced is certified\*.
  - 2) Not a manufactured microsphere or cenosphere (from fly ash production)

\* Certified by an independent testing laboratory, which is a standard practice in the lightweight aggregate industry. This documentation is readily available from the commercial suppliers. Product literature which simply states “ASTM C330 compliant” is not sufficient to meet this requirement. Refer to sample *Project Overview and Technical Addendum* (<http://www.asce.org/rules-and-regulations/>) for an example certification.



### 3.3.4 Water/Cementitious Material (w/cm) Ratio

There is no limit for the w/cm ratio. The water content of all admixtures shall be considered when calculating the w/cm ratio.

### 3.3.5 Solids Content

Only latex solids, dyes, and admixtures in powder form are to be accounted for in the determination of solids content. Disregard the contribution of solids from other admixtures.

### 3.3.6 Unit Weight

#### 3.3.6.1 Wet (Plastic) Unit Weight

The wet unit weight, per ASTM C138, is to be reported in Table 3.1. It is understood that the concrete placed on the canoe may be denser than the unit weight determined per ASTM C138 due to method of placement.

#### 3.3.6.2 Dry Unit Weight

The dry unit weight is based on oven-dried conditions. It is recommended that the samples be dried for a period of no less than 24 hours at a temperature not to exceed 250°F. Once dried, samples must be protected from absorbing moisture.

### 3.3.7 Curing

Concrete shall be cured after placement and finishing using an appropriate curing method. Liquid membrane-forming compounds certified to meet either ASTM C309 or ASTM C1315, with a volatile organic content (VOC) less than or equal to 350 g/L and stated as such on the product data sheet, may be applied to any portion of the canoe at the discretion of the team. Equivalent products may be submitted to the CNCCC for consideration as an approved equal.

The application of either a curing compound or curing and sealing compound to any portion of the canoe shall be limited to a maximum of two (2) coats following the manufacturer's recommended procedure for application and thickness.

## 3.4 DOCUMENTATION

### 3.4.1 Mixture Proportions Table

The proportions of the concrete mixtures used in the canoe are to be summarized in Table 3.1, "Concrete Mixture Data Table," and shall be included in Appendix B of the Design Paper (Section 6.2.2.m). **Teams shall be responsible for mathematical accuracy and correct determination of all values and the proper use of significant digits.** Table 3.1 is available for download. Please refer to Appendix C, "General Guidelines for Concrete Mixture Data Table," for step-by-step instruction on how to complete the table. A copy of the table will be made available on the ASCE canoe website for download.

### 3.4.2 Engineering Properties

The concrete density, strengths and air content shall be reported in English units to the accuracies outlined in the applicable industry standards (e.g., ASTM C39, C109, C138 and C496, etc.) on the *Compliance Certificate* (Section 7.1.2.b)

### 3.4.3 Material Technical Data Sheets

Material Technical Data Sheets (MTDS) for each material used in the canoe are to be presented under Tab D of the *Project Overview and Technical Addendum* (Section 7.1.2.e). This includes, but is not limited to, cementitious materials (including cement), aggregate (other than natural or manufactured sands), chemical admixtures, and pigments. Each MTDS should show compliance to the rules (ex: Polymer Modifier should list it complies with ASTM C1438, Type II). **Safety Data Sheets (SDS) are not equivalent documentation for MTDS. SDS may be included as a supplement to the MTDS, but not as a substitute.**

Any unaddressed equivalent materials shall be submitted to and approved by the CNCCC as alternatives before their application.

### 3.4.4 Aggregate Sample(s)

A 500 milliliter (min.) representative samples of both the individual aggregates and composite aggregate blends used in each concrete mixture shall be made available as part of the Product Display (Section 10.1.b). Samples shall be provided in transparent containers, and labeled accordingly. Composite aggregate blends should be of the same proportion of each concrete mixture.

### 3.4.5 Concrete Sample(s) Cylinders

A 3 in. or 4 in. diameter standard cylindrical sample of each concrete mixture used in the canoe shall be made available for compliance checking as part of the Product Display (Section 10.1.b). The sample(s) shall be a quality control (QC) test cylinder taken at the time of construction and be representative of the in-place density, color, consistency and make-up of the concrete(s) used in the canoe. The concrete cylinders shall be provided in two halves. If several colors of a given concrete mixture is used, provide only one (1) sample of that mixture (i.e., samples of each color are not required).

One (1) complete (unbroken) 3 in. or 4 in. diameter standard cylindrical sample of each concrete mixture used must be available for the purposes of unit weight verification. These samples should be prepared per ASTM C39. If several colors of a given concrete mixture is used, provide only one (1) sample of that mixture (i.e., samples of each color are not required). Cylinders are subject to a unit weight check at the National Competition with the measured unit weight compared to that reported on the *Compliance Certificate*.

The complete (unbroken) samples provided shall be oven-dried (refer to Section 3.3.4.2, Dry Unit Weight).

**TABLE 3.1—SUMMARY OF MIXTURE PROPORTIONS**

**MIXTURE DESIGNATION:**

<b>CEMENTITIOUS MATERIALS</b>							
<i>Component</i>		<i>Specific Gravity</i>		<i>Volume (ft<sup>3</sup>)</i>		<i>Amount of CM (mass/volume) (lb/yd<sup>3</sup>)</i>	
<i>Cement, ASTM Type</i>						<i>Total Amount of cementitious materials</i> _____ lb/yd <sup>3</sup> <i>c/cm ratio</i> _____	
<i>Cementitious Material 1</i>							
<i>Cementitious Material 2</i>							
<i>Cementitious Material 3</i>							
<b>FIBERS</b>							
<i>Component</i>		<i>Specific Gravity</i>		<i>Volume (ft<sup>3</sup>)</i>		<i>Amount of Fibers (mass/volume) (lb/yd<sup>3</sup>)</i>	
<i>Fiber 1</i>						<i>Total Amount of Fibers</i> _____ lb/yd <sup>3</sup>	
<i>Fiber 2</i>							
<b>AGGREGATES</b>							
<i>Aggregates</i>	<i>ASTM C330*</i>	<i>Abs (%)</i>	<i>SG<sub>OD</sub></i>	<i>SG<sub>SSD</sub></i>	<i>Base Quantity (lb/yd<sup>3</sup>)</i>		<i>Volume (ft<sup>3</sup>)</i>
					<i>OD</i>	<i>SSD</i>	
<i>Aggregate 1</i>	Y / N						
<i>Aggregate 2</i>	Y / N						
<i>Aggregate 3</i>	Y / N						
<b>ADMIXTURES</b>							
<i>Admixture</i>	<i>lb/gal</i>	<i>Dosage (fl.oz/cwt)</i>		<i>% Solids</i>	<i>Amount of Water in Admixture (lb/yd<sup>3</sup>)</i>		
<i>Latex (if used)</i>					<i>Total Water from Admixtures, <math>\sum W_{adm}</math></i> _____ lb/yd <sup>3</sup>		
<i>Liquid Dye (if used)</i>							
<i>Admixture</i>							
<i>Admixture</i>							
<b>SOLIDS (LATEX, DYES AND POWDERED ADMIXTURES ONLY)</b>							
<i>Component</i>		<i>Specific Gravity</i>		<i>Volume (ft<sup>3</sup>)</i>		<i>Amount (mass/volume) (lb/yd<sup>3</sup>)</i>	
<i>Latex (if used)</i>						<i>Total Solids from Admixtures</i> _____ lb/yd <sup>3</sup>	
<i>Liquid Dye (if used)</i>							
<i>Powdered Admixture</i>							
<b>WATER</b>							
				<i>Amount (mass/volume) (lb/yd<sup>3</sup>)</i>		<i>Volume (ft<sup>3</sup>)</i>	
<i>Water, lb/yd<sup>3</sup></i>						<i>w:</i>	
<i>Total Free Water from All Aggregates, lb/yd<sup>3</sup></i>						$\sum W_{free}$ :	
<i>Total Water from All Admixtures, lb/yd<sup>3</sup></i>						$\sum W_{adm}$ :	
<i>Batch Water, lb/yd<sup>3</sup></i>						<i>W<sub>batch</sub>:</i>	
<b>DENSITIES, AIR CONTENT, RATIOS AND SLUMP</b>							
	<i>cm</i>	<i>fibers</i>	<i>aggregates</i>	<i>solids</i>	<i>water</i>	<i>Total</i>	
<i>Mass of Concrete, M, (lb)</i>						$\sum M$ :	
<i>Absolute Volume of Concrete, V, (ft<sup>3</sup>)</i>						$\sum V$ :	
<i>Theoretical Density, T, (= <math>\sum M / \sum V</math>)</i>	<i>lb/ft<sup>3</sup></i>		<i>Air Content [= (T - D)/T x 100%]</i>			<i>%</i>	
<i>Measured Density, D</i>	<i>lb/ft<sup>3</sup></i>		<i>Slump, Slump flow</i>			<i>in.</i>	
<i>water/cement ratio, w/c:</i>			<i>water/cementitious material ratio, w/cm:</i>				

\* Indicate if aggregate, other than manufactured glass microspheres and/or cenospheres, is compliant with ASTM C330.

## TERMS AND FORMULAS FOR TABLE 3.1

- Abs** = absorption of an aggregate, whether taken as a whole, the coarse, or the fine aggregate, %.
- cwt** = hundred weight of cementitious material (example 860 lb/yd<sup>3</sup> of cm is 8.6 cwt)
- MC<sub>total</sub>** = total moisture content referenced to the oven-dried condition of the aggregate, %.
- MC<sub>free</sub>** = free moisture content, referenced to the saturated, surface-dry condition (SSD), of the aggregate, %.
- MC<sub>stk</sub>** = stock moisture content of the aggregate, %.
- M** = the measured density (wet, plastic) of concrete test cylinders, per ASTM C138, lb/ft<sup>3</sup>.
- T** = the theoretical density of concrete (zero air voids), per ASTM C138, lb/ft<sup>3</sup>.
- SG<sub>SSD</sub>** = specific gravity, in the saturated, surface-dry condition, of aggregate, dimensionless.
- SG<sub>OD</sub>** = specific gravity, in the oven-dried condition, of aggregate dimensionless.
- W<sub>SSD</sub>** = mass, in the saturated, surface-dry condition, of aggregate per unit volume of concrete, lb/yd<sup>3</sup>.
- W<sub>OD</sub>** = mass, in the oven-dried condition, of aggregate per unit volume of concrete, lb/yd<sup>3</sup>.
- W<sub>stk</sub>** = mass, in the stock moisture condition, of the aggregate per unit volume of concrete, lb/yd<sup>3</sup>.
- w<sub>adm</sub>** = the mass of water in the admixtures, per unit volume of concrete, lb/yd<sup>3</sup>.
- w<sub>batch</sub>** = the mass of water to be batched per unit volume of concrete when the aggregates are in a stock moisture condition, lb/yd<sup>3</sup>.
- w<sub>free</sub>** = free water carried into the batch by a wet per unit volume of concrete, lb/yd<sup>3</sup>.

***Each one of these formulas should be applied to each aggregate source:***

$$Abs = \frac{W_{ssd} - W_{od}}{W_{od}} \times 100\%$$

$$MC_{total} = \frac{W_{stk} - W_{od}}{W_{od}} \times 100\%$$

$$MC_{free} = MC_{total} - Abs$$

$$W_{SSD} = \left( 1 + \frac{Abs}{100\%} \right) * W_{OD}$$

$$w_{free} = W_{OD} \times \left( \frac{MC_{free}}{100\%} \right)$$

Note that  $w_{free}$  can be a negative number indicating a dry and absorptive aggregate.

$$W_{stk} = W_{SSD} + w_{free}$$

Then, for the mixture as a whole:  $w_{batch} = w - \left( w_{free} + \sum w_{adm} \right)$

***The following formula should be applied to all admixtures in liquid form:***

$$w_{adm} = dosage \text{ (fl oz/cwt)} * cwt \text{ of cm} * water \text{ content } (\%) * 1 \text{ gal}/128 \text{ fl oz} * lb/\text{gal of admixture}$$

***The following formula should be applied to latex and liquid dyes, only:***

$$S = dosage \text{ (fl oz/cwt)} * cwt \text{ of cm} * solid \text{ content } (\%) * 1 \text{ gal}/128 \text{ fl oz} * lb/\text{gal of admixture}$$

## Section 4 – REINFORCEMENT

**CNCCC Intent** – *The intent of this section is to provide the specifications for the materials that teams may use to serve as primary reinforcement. In general, teams are permitted to develop a reinforcement scheme that (a) uses materials that contain sufficient open space measured in terms of percent open area (POA), (b) the total thickness of the reinforcing layers is equal to or less than 50% of the total thickness of the reinforced concrete composite, and (c) the reinforcing materials do not have post-manufacturer applied coatings that enhance the properties of the reinforcement.*

### 4.0 GENERAL

All primary reinforcement shall be covered in concrete. All materials not part of a concrete mixture or a floatation material shall be classified as reinforcing material and shall comply with the specifications outlined below.

### 4.1 REFERENCES

The publications listed below form part of this specification to the extent referenced. The latest version of each standard shall govern wherever referenced. The publications are referred to in the text by basic designation only.

ASTM C1116                      Standard Specification for Fiber-Reinforced Concrete and Shotcrete

### 4.2 MATERIALS

#### 4.2.1 Mesh and Grids

All materials serving as primary reinforcement shall have sufficient open space to allow for the mechanical bonding of the concrete composite as measured by its *percent open area* (POA). Solid mats or plates for reinforcing are not permitted. **Pre-impregnated (pre-preg) materials which contain resins and require heat to complete polymerization, are not permitted.** Solid mats and plates are described as materials that require additional bonding agents or post-manufacturer perforations to keep the reinforcement from delaminating (i.e., there is a lack of open space between the reinforcement sufficient for mechanical bonding).

#### 4.2.2 Strands, Tendons, and Bars

Strands, tendons, and bars are materials less than ½ inch wide and are used to make a reinforcement grid or used in pre- or post-tensioning. When used individually, they must meet thickness requirements, but are not subject to percent open area. Grids consisting of strands, tendons, and bars are subject to thickness and percent open area requirements (Section 4.3).

#### 4.2.3 Bearing Plates and Fasteners

Bearing plates and fasteners used for pre- or post-tensioning of tendons are permitted and are not subject to the thickness or percent open area requirements on the following page. The location of the bearing plates is limited to within 2 feet from the bow and stern sections. The thickness of any bearing plate itself is limited to ¼ inch.

#### 4.2.4 Fibers

Fibers dispersed within the concrete matrix (ASTM C1116) are secondary reinforcement and not subject to the measurements listed in Section 4.3.

### 4.3 MEASUREMENT

#### 4.3.1 Thickness

The thickness of a layer of reinforcement is defined as follows: a single layer of the reinforcing is to be placed on a flat surface; a piece of plate glass, ¼ inch or thinner, is to be placed on the reinforcement; when subjected to the weight of the glass alone, the distance from the bottom of the plate to the top of the supporting flat surface is the thickness of a single layer. The sum of all such measured thicknesses divided by the total thickness of the canoe wall or structural element at any point in the canoe shall not exceed 50%. All canoe elements, including but not limited to, the hull, ribs, gunwales, thwarts, bulkheads, etc., and the connections of structural elements to the canoe wall are subject to this rule. If individual rods or reinforcing bars are used in such a way that they cross each other, this use constitutes at least two (2) layers of reinforcement.

#### 4.3.2 Percent Open Area

The minimum percent open area (POA) of any layer of reinforcing material is 40%. The determination of the POA is obtained by the following equation (sample calculation below):

$$POA = \frac{\sum Area_{open}}{Area_{total}} \times 100\%$$

where:  $\sum Area_{open}$  is the total open area (i.e., the area of the apertures)  
 $Area_{total}$  is the total area of the reinforcement specimen

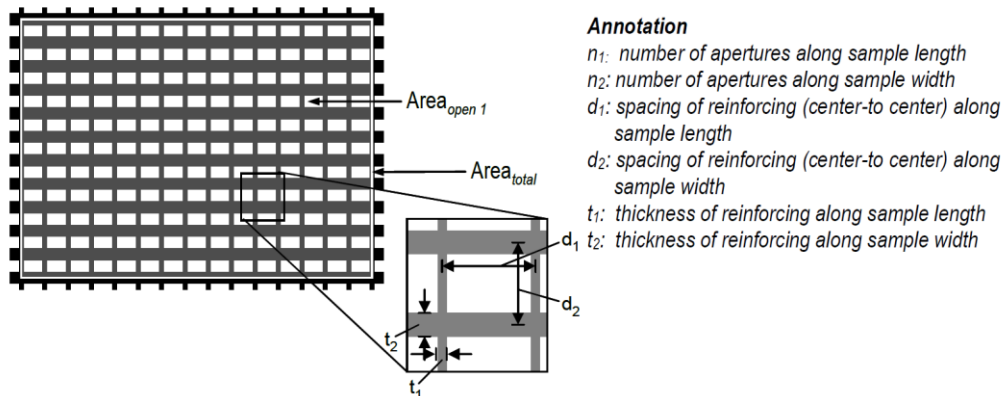

**Given:** A glass fiber reinforcing mesh with a 0.0625 square inch aperture size (0.30 in. by 0.30 in. aperture dimensions). The thickness of fibers along the sample length was determined to be 0.10 inches wide while the thickness along the sample width was found to be 0.20 inches wide. (See figure above)

**Determine:** Percent Open Area (POA) of the glass fiber reinforcing mesh

**Solution:**

$$d_1 = \text{aperture dimension} + 2(t_1 / 2) = 0.30 + 2(0.10/2) = 0.40 \text{ inch}$$

$$d_2 = \text{aperture dimension} + 2(t_2 / 2) = 0.305 + 2(0.10/2) = 0.50 \text{ inch}$$

$$\text{Length}_{\text{sample}} = n_1 d_1 = [(15) \times 0.40] = 6.0 \text{ inches}$$

$$\text{Width}_{\text{sample}} = n_2 d_2 = [(11) \times 0.50] = 5.50 \text{ inches}$$

$$\sum Area_{open} = n_1 \times n_2 \times Area_{open1} = 15 \times 11 \times 0.09 \text{ in}^2 = 14.85 \text{ in}^2$$

$$Area_{total} = \text{Length}_{\text{sample}} \times \text{Width}_{\text{sample}} = 6.0 \text{ in} \times 5.50 \text{ in} = 33.0 \text{ in}^2$$

$$POA = \sum Area_{open} / Area_{total} \times 100\% = 14.85 / 33.0 \times 100 = 45\% (> 40\% \text{ min.}) \text{ OK!}$$

**Figure 4.1 – Percent Open Area (POA) Determination and Sample Calculation**

Teams are permitted to modify a given mesh by removing strands as needed to achieve the required POA. Teams may fabricate meshes or grids by placing (weaving, tying) material in the “as-received” condition. Once fabricated, teams are not permitted to treat the material (e.g., apply coatings or heat).

The “as-received” condition is defined as a commercially available “off the shelf” product directly available to a consumer which has not been modified by a third-party (for example, fiberglass can be used as is, but to have a third-party make a grid out of it, then “delivering” it to the team and then considering it “as-received” is not allowed).

## 4.4 DOCUMENTATION

### 4.4.1 Reinforcement Samples

#### 4.4.1.1 Mesh and Grids

A 12 in. x 12 in. (min.) square sample of each reinforcement material (mesh or grid) used shall be made available as part of the Product Display (Section 10.1.b).

#### 4.4.1.2 Strips, Tendons and Bars

If the reinforcement is “as-received” as a rolled strip (less than 12 in. wide), a 12 in. long sample strip shall suffice. If bars, tendons or strands are utilized, a sample of 12 in. (min.) length shall be provided.

#### 4.4.1.3 Fibers

For any fibers used in the concrete mixtures, individual sample(s) of 50 mL (min.) shall be provided.

### 4.4.2 Material Technical Data Sheets

Material Technical Data Sheets (MTDS) for each reinforcement material used shall be presented under Tab D of the *Project Overview and Technical Addendum* (Section 7.1.2.e). Some materials from local stores may not have an official MTDS available; however, a printout (from the store website or from the packaging) showing basic strength properties of the material may be included instead. If you are in doubt of a product or MTDS, contact the CNCCC for review.

## Section 5 – FINISHING

**CNCCC Intent** – *The intent of this section is to provide the specifications for the various materials that teams may use to finish the surface of the canoes. In general, teams shall provide the names of the school and canoe at their specified heights and locations. Teams may (a) use integrally colored concrete, and (b) apply sealers to specified areas of the canoe.*

### 5.0 GENERAL

All materials used shall be environmentally safe.

### 5.1 REFERENCES

The publications listed below form part of this specification to the extent referenced. The publications are referred to in the text by basic designation only.

ASTM C309	Standard Specification for Liquid Membrane-Forming Compounds for Curing Concrete
ASTM C979	Specifications for Pigments for Integrally Colored Concrete
ASTM C1315	Liquid Membrane-Forming Compounds Having Special Properties for Curing and Sealing Concrete

### 5.2 LETTERING

The name of the school and canoe shall be prominently displayed on the exterior of the canoe, above the waterline, on both sides, with individual letters. The school name shall consist of letters 5" ± 1/2" high; the canoe name shall consist of letters 4" ± 1/2" high. Letter height includes any outlines, shadows, ascenders and descenders, etc., used and may vary if it is within the specified range. If the complete name of the college or university is 31 characters or more (including all letters and spaces between words), the name may be abbreviated. To use an abbreviation, teams must submit an RFI for approval by the CNCCC. Teams granted approval for abbreviated names for the 2016 and 2017 competitions do not need to resubmit an RFI. A listing of those schools will be provided on the ASCE Concrete Canoe Facebook page. The abbreviated name must still clearly indicate the specific college or university competing and, as applicable; it should also include state or city.

### 5.3 GRAPHICS

Graphics created using concrete coloring agents and pigments within the concrete mix design (i.e., integrally colored concrete) are not limited in dimension or frequency. Letters for canoe and school names created using coloring agents and pigments are limited to the sizes outlined in Section 5.2. Any coloring agents or pigments used shall be in accordance with ASTM C979.

### 5.4 ADHESIVE APPLIQUÉS

The use of adhesive appliqués is limited to the lettering used for the school and canoe names.

### 5.5 STAINS AND PAINTS

The use of stains and paints of any kind is strictly prohibited.



## 5.6 CONCRETE SEALERS

Only clear, non-pigmented concrete sealers (penetrating or surface coating) may be applied to any portion of the canoe at the discretion of the team. The sealer may be either:

- a. silane- or siloxane-based penetrating sealer with a VOC of less than or equal to 350 g/L,  
or
- b. liquid membrane-forming compound for curing and sealing that is compliant with ASTM C1315 requirements (there are no VOC requirements with this option)

**VOC listings, ASTM C1315 compliance, as applicable, are to be stated as such on the product technical data sheet.** Post-manufacturer additives such as glitter or other particulate material are not permitted. Equivalent products shall be submitted to the CNCCC for consideration as an approved equal.

The application of sealer to any portion of the canoe shall be limited to a maximum of two (2) coats, following the manufacturer's recommended procedure for application and thickness.

## 5.7 DOCUMENTATION

### 5.7.1 Material Technical Data Sheets

Material Technical Data Sheets (MTDS) for each material used in the construction of the canoe shall be presented under Tab D of the *Project Overview and Technical Addendum* (Section 7.1.2.e). This includes, but is not limited to pigments, sealers and curing compounds.

## Section 6 – DESIGN PAPER

**CNCCC Intent** – *The intent of this section is to provide the specifications for the Design Paper. In general, the Design Paper shall cover various areas related to the design and construction of the concrete canoe such as concrete and composite development and testing, project management, innovations and sustainable aspects of the design.*

### 6.0 GENERAL

Scoring shall be based on the criteria in Appendix A-1. All paper shall become the property of ASCE and may be used for publication and/or distribution.

### 6.1 REFERENCES

The publications listed below form part of this specification to the extent referenced. The latest version of each standard shall govern wherever referenced.

ASCE (2014 or current version). "Permission Basics" Publishing Books with ASCE <http://ascelibrary.org/page/authors> (October 2014).

ASCE (2014 or current version). "Author-Date References" Publishing Books with ASCE. <http://ascelibrary.org/page/authors> (October 2014).

### 6.2 DESIGN PAPER

#### 6.2.1 General Requirements

The body and appendices of the Design Paper shall be presented on white 8 ½ in. by 11 in. pages in portrait orientation. No background images or watermarks are permitted behind the text in the body or appendices of the paper. Appendix cover sheets are permitted, but are not required. No blank pages shall be inserted into the report. All pages of the report, including the organization chart, project schedule, construction drawing, and appendices shall maintain a minimum of ½ in. margins on all sides.

Body text shall be in English and use 12-point, normal width character spacing, Times New Roman or Arial font, and be at least single spaced. Section headings and subheadings may be of any legible font type or size.

The hard copy of the report shall consist of a single-sided report cover, single-sided pages for the body and appendices, and a back cover.

Body pages, except for the Table of Contents and Executive Summary, shall be numbered beginning with the number one (1). The Table of Contents and Executive Summary shall be limited to a total of one (1) page each, numbered with lowercase Roman numerals i and ii, respectively. Pages located in the appendices shall be numbered in such a way that the appendix and page number are clearly listed (e.g., A-1, A-2, B-1, B-2; A1, A2, B1, B2; etc.) as appropriate.

Photographs, tables, line drawings, graphs, headers and footers are permitted and shall be counted as part of the page limit defined herein. Captions used shall be no less than 8 point, normal width, and any legible font type.

Items such as page numbers, logos, images/designs, section headings, etc. may be incorporated into the header and footer of the pages and are not subject to the font requirements of the body text. The header and footer may be located within the margin itself (i.e., outside of the body text limits). Headers and footers are not required on the Project Schedule or Construction Drawing. Material on the report cover, appendix cover pages (if used), and Table of Contents may not be directly referred to in the body pages.

### 6.2.2 Format

The reports must adhere to the following format, and the following must be included:

- a. **Report Cover:** A protective plastic cover is optional on top of the report cover.
- b. **Table of Contents** (Page i): Provide a Table of Contents including the various sections of the report, List of Figures, List of Tables, and List of Appendices, as appropriate. No other information, including photographs, shall be included on this page.
- c. **Executive Summary** (Page ii): Provide basic information about the team including the name and location of the school, which conference the team participates in, and the overall placement in the past three (3) years of competition. The following properties shall be provided of each mixture included in Appendix B – *Mixture Proportions*: concrete density(ies), including both the wet (plastic) and oven-dried unit weights, concrete compressive strength(s), concrete tensile strength(s), concrete composite flexural strength(s) and concrete air content(s). Provide applicable dimensions, such as length, width, depth, and thickness. Provide the name, weight\*, color(s) of the canoe, and the type(s) of primary and secondary reinforcement used. Highlight any innovative or new features of the hull design, structural analysis, mixture design, construction, project management, and sustainability, as applicable.

*(\*For Conference Competitions only, if the canoe is not completed prior to the submission of the design report, an estimated weight is to be provided and noted as such.)*

- d. **Project and Quality Management** (Pages 1 and 2): Present the method(s) of project management and present the planning process as it relates to budget, schedule, scope, and risk management (as it applies to aspects of the project other than health and safety) involved throughout the project. Discuss the financial and resource allocation associated with material procurement and construction. List major milestone activities and how these were determined and achieved. Present critical path activities and describe how this critical path was determined. Provide the total number and a breakdown of person-hours dedicated to project management, hull design, structural analysis, mixture design development, mold construction, canoe construction (research, testing, and construction), finishing, and academics (design paper, presentation, and display). Discuss the safety program implementation as it applies to both the material testing and construction of the canoe. Include sustainable aspects related to the overall project as they relate to social, economic, and environmental impacts (i.e.: other aspects not included in subsequent sections). Present a discussion of differences between the initial schedule and the actual project schedule.

Discuss the quality control and quality assurance (QA/QC) plan/program implemented by the team as it relates to non-construction related aspects of the overall project.

Items to consider include, but are not limited to, material procurement and compliance review, document tracking and review, training (other than paddler training), rule and RFI consensus, calculations and work product review, etc.

- e. **Organization Chart** (Page 3): Include a project team organization chart with team member names, role(s), tasks, or areas in which they made contributions at any time during the project. Include the year (Fr., So., Jr., Sr., Grad) for all members included. Indicate which two team members are the team captains. This chart may be in either portrait or landscape orientation and may include a background image or design.
- f. **Hull Design and Structural Analysis** (Pages 4 and 5): Provide a description of goals and the holistic design approach of the canoe including its geometry and structural elements. Discuss final design selections and indicate if it is a direct copy or minor modification of an existing canoe, or a new design. Provide a description and reasoning of the selected hull geometry (rocker, chine, shape, etc.) including all applicable dimensions and any specific relevant features of the design.

Provide a description of the holistic approach to the analysis and material design requirements. Include quantitative results from the analysis of forces, stresses, etc. Describe loading cases (including racing, transportation, and display), support conditions, assumptions, and analysis tools used. Include material property values/design specifications for the concrete, reinforcement, and composite that must be achieved in the mixture development. If applicable, discuss how requirements for bulkheads, thwarts, ribs, or other structural elements are determined.

The structural analysis conducted by the teams is to be limited to 2-D analysis only. The analysis should be based on concepts of mechanics of materials, strength of materials, and reinforced concrete design. The use of programs such as, but not limited to, MathCAD®, Matlab® and Microsoft Excel™ to perform repetitive, routine calculations is allowed. Advanced analytical methods, such as finite element, are not to be included in the Design Paper nor mentioned in the Oral Presentation.

- g. **Development & Testing** (Pages 6, 7, and 8): Provide a description of goals. Describe the baseline concrete and reinforcement materials considered and explain why this was chosen. Include quantitative test results from this baseline. Use and refer to standard test methods where possible. If this is not the final mix and reinforcement used in the construction of the canoe, describe the iterative process of going from the baseline to achieving the desired material and composite properties and explain the reasons for any adjustments. Provide the physical properties and composition of the individual aggregate sources, including specific gravity, absorption and particle size. Comment on the admixtures tested and used in preparing the concrete and explain the motivation for each selection and how they affect the final product. Include the final concrete and composite test results. Discuss any primary reinforcement considered, tested, and used and the reasons for this selection, including the motive for the layering scheme chosen. Compare the final material properties to the design specifications determined in the analysis. Discuss new or innovative ideas, materials, and methods that were implemented in the development of the concrete composite and the impacts on budget, schedule, and safety. Highlight any sustainable products that have been incorporated into the materials being used.
- h. **Construction** (Pages 9 and 10): Describe the process used for form material selection and form construction. Include the rationale for the choices made. Discuss the method(s) of mixing and placement of concrete and reinforcement along with the construction techniques to implement the layering scheme chosen. Provide a

description of the curing conditions and length of curing used. Describe the processes used for form removal, concrete finishing, and aesthetics. Include discussion of new or innovative ideas implemented in the construction of the mold and/or canoe and their impacts on budget, schedule, and safety. Discuss the quality control and quality assurance practices as they apply to concrete mixing and concrete placement during the construction of the canoe. Highlight any sustainable aspects that have been incorporated into the construction process.

- i. **Project Schedule** (Page 11): The project schedule shall be presented on a single sided 11 in. by 17 in. page in landscape orientation and folded (Standard Z-fold). The text for the project schedule does not need to meet the requirements of the body text; however, they should be of a font and size that is legible.

The project schedule is a tool that should be used to help plan and successfully execute the important activities associated with the design and construction of the concrete canoe.

**A preliminary project schedule will be due to be submitted on Wednesday, November 1, 2017.** Refer to Section 6.3 – SUBMISSIONS for specific details.

Include a project schedule which depicts planned (from the team's submitted preliminary schedule) and actual execution dates for all major activities and milestones and clearly denote all activities on the Critical Path. At the NCCC, judges will compare the schedule submitted on November 1, 2017, to the one submitted in the design paper.

A penalty will be assessed if a Nationals attendee did not submit a preliminary schedule in November to the specified website.

- j. **Construction Drawing** (Page 12): The construction drawing shall be presented on a single sided 11 in. by 17 in. page in landscape orientation and folded (Standard Z-fold). The text for the construction drawing does not need to meet the requirements of the body text; however, they should be of a font and size that is legible.

Include one (1) construction drawing and bill of materials for the canoe. (Example is given in Figure 6.1. The title block and bill of materials can differ in appearance if they are in a standard engineering format.) The drawing shall show isometric, elevation, plan, and typical composite cross-section views of the canoe (not the mold) with applicable dimensions and other details as needed to construct. A bill of materials listing all material quantities used to construct the canoe shall also be displayed. Materials should include, but are not limited to binding material(s), aggregate(s), admixtures(s), fibers(s), primary reinforcement, sealers, flotation material, and lettering. Additional details, cross sections, etc. may be added to clearly present construction techniques.

- k. **Appendix A – References:** Parenthetical references following the format defined in 6.1 References. Past design reports, ASTM and/or other industry standards, technical software, and published material, shall be cited and properly referenced. Papers using plagiarized material shall be disqualified without appeal.
- l. **Appendix B – Mixture Proportions:** A table listing any mixture of concrete used in the construction of the canoe shall be included in Appendix B. For each mixture(s) used, a *Concrete Mixture Data Table* (Table 3.1) shall be provided. Concrete mixes

which are different only in color pigment (other constituents and proportions are the same) shall be considered as one (1) mixture and only one (1) table shall be presented. In this instance, indicate as a note that the color varies for the mixture. One separate page for each data table shall be used.

Provide a detailed, step-by-step calculation of the mixture proportion (yielded) of the canoe's primary mixture, including the determination of volumes of the concrete constituents, gravimetric air content, w/c and w/cm ratios, and wet unit weight. Show compliance with ASTM C330 volume requirement is met. Provide each step of the calculation (do not give an example calculation for determining the volume of one aggregate and then say, "it can be shown that the volumes of the others are....").

The primary mixture shall be considered as either the mixture that occupies the most volume in the canoe or is considered by the team to be the main structural mixture of the canoe. (Refer to Appendix C which is a guideline for completing the table.)

m. **Appendix C – Example Structural Calculation** (3 pages total): This may be in either portrait and/or landscape orientation. Provide a detailed, step-by-step example calculation (showing all relevant equations, variables and inputs including proper units) for the determination of internal stresses based on the following scenario:

- Four (4) person co-ed race
- Paddlers are to be considered as point loads, the magnitude of which is to be determined by the team
- Male paddlers positioned at locations equal to 20% and 80% of the total length of the canoe (as measured from the bow)
- Female paddlers positioned at locations equal to 35% and 65% of the total length of the canoe (as measured from the bow)

Use non-transformed cross-sectional properties (i.e., neglect the use of reinforcement and the ratio of concrete-to-reinforcement moduli). The cross-section that is to be analyzed is at the point of maximum moment under this loading condition.

At a minimum, the following shall be provided in the calculation: list of all assumptions (cite references as applicable), free body diagram with all relevant point and distributed loads (canoe weight, etc.) and their respective measurements, resulting shear (V) and bending moment (M) diagrams, cross-sectional properties including applicable dimensions, moments of inertia, and location of the neutral axis, and values of the internal stresses based on the principles of the mechanics of materials. The cross-sectional properties of the representative section are to be approximated by hand calculations (i.e., the use of exact values from programs such as AutoCAD are not permitted). This portion of the calculation is limited to two (2) pages.

Compare the results of the analysis of this scenario to the results of the analyses performed under the various scenarios (racing, transportation, etc.) considered by the team. Calculations for the other scenarios are not to be provided (just the results of the analyses). The results for the other scenarios can be based from computer programs used for doing the routine calculations. This portion of the calculation is limited to one (1) page.

Note: Computer programs can be used for doing the routine calculations for the Structural Analysis section of this report (see Section 6.2.2.g). This appendix is to

show the step-by-step calculation version of determining the stresses in the routine analysis.

- n. **Appendix D – Hull Thickness/Reinforcement and Percent Open Area Calculations** (limit of 3 pages): Present the measurements and calculations of the reinforcement(s) and hull thickness for the various canoe elements (i.e., walls, ribs, gunwales, thwarts and bulkheads) as applicable (Section 4.3.1) and percent open area (Section 4.3.2).
- o. **Appendix E – Repair Procedures Report or Reconstruction Request** (if necessary): If the canoe is damaged during or after the Conference Competition and repair is required, either a *Repair Procedures Report* or *Reconstruction Request* shall be included as an appendix to the report. The CNCCC disposition and supporting documentation shall be presented in Appendix D, as well. (*Note: Reports submitted for Conference Competitions will not have this appendix*)
- p. **Back Cover:** This cover shall be left blank. A blank piece of paper at the end is not considered a back cover. A back cover is not required for the electronic copy of the report.

## 6.3 SUBMISSIONS

### 6.3.1 Preliminary Project Schedule

ASCE has scheduled a webinar on “Fundamentals of Project Scheduling and the Critical Path Method” for Wednesday, October 4, 2017 at 2 p.m. [Eastern].

To participate in this Webinar

<https://cc.readytalk.com/registration/#/?meeting=r8b2gdjqljab&campaign=er2en307pf1g>

Or view the webinar after October 4, 2017

<http://www.asce.org/continuing-education/past-elearning-webinars/>

**A preliminary project schedule will be due to be submitted by 11:59 pm [Eastern] Wednesday, November 1, 2017.** All schools should upload their project schedule at:

/Organizational/Department/SYM Programs/CSM/eRoom/Conf Canoe Papers

[https://files.asce.org/xythoswfs/webui/xy-e1965140\\_1-t\\_wRyl2mTM](https://files.asce.org/xythoswfs/webui/xy-e1965140_1-t_wRyl2mTM)

This is a Read/Write link (no delete). The main folder contains a folder for each Student Conference, and within each Conference Folder is a folder for each school in that conference.

### 6.3.2 Acknowledgement Form

The *Acknowledgement Form* which was provided along with these Rules and Regulations is required to be reviewed and signed off by each team to acknowledge the various requirements of ASCE Student Chapter eligibility, individual registered participant eligibility, and submissions for Conference and National Competitions including deadlines, formats and locations. **The form is due by 11:59 pm [Eastern] Wednesday, November 1, 2017** (uploaded to the same folder as listed in Section 6.3.1).

### 6.3.3 Conference Competition

Each school shall provide five (5) bound copies of the Design Paper by the deadline set by the conference host school. Electronic copies of the Design Paper and *Project Overview & Technical Addendum*, in the formats listed below, are also to be provided by the deadline. The electronic copy of the Design Paper and *Project Overview & Technical Addendum* shall be provided as separate documents in PDF format. A copy of the Design Paper shall also be provided in a document file of the word processing program used in the creation of the PDF (such as Microsoft Word™, Microsoft Publisher™, Adobe InDesign, etc.). The files shall not be password protected.

**Host schools are not permitted to change the requirements for submitting hard and/or electronics copies of the Design Paper and *Project Overview and Technical Addendum*.**

Submit electronic copies to the same location specified in Section 6.3.1. **The electronic submission shall be considered the official and final version of both the Design Paper and *Project Overview and Technical Addendum*.** The hard copies and electronic submission of the Design Paper and *Project Overview and Technical Addendum*, must be received by the date specified by the conference host school or be subject to penalties.

**The CNCCC does not dictate the deadlines for submission at the Conference Competitions; however, the CNCCC recommends that the host school provides a deadline at least 3 to 4 weeks prior to the competition to give judges adequate time to review and score the papers.**

### 6.3.4 National Competition

Each school shall provide six (6) bound copies of the Design Paper and shall upload electronic copies of the Design Paper and *Project Overview and Technical Addendum* following directions provided in the invitation letter. The electronic files shall be in the same formats as outlined in Section 6.3.1. **All bound copies of the Design Paper must be received no later than 5:00 pm EDT, Thursday, May 24, 2018 at the following address:**

ASCE Student Services  
1801 Alexander Bell Drive  
Reston, VA 20191  
Attn: 2018 NCCC

**The electronic submission is considered the official version of the Design Paper and *Project Overview and Technical Addendum*.** Substitutes will not be accepted at the National Competition. The Design Paper and *Project Overview and Technical Addendum* must be uploaded no later than 5:00 pm EDT, Thursday, May 24, 2018. **Submissions not received by the deadline will be subject to penalties. Penalties will be assessed for partial or incomplete submissions.**

## 6.4 DESIGN PAPER DEDUCTIONS

Teams shall be made aware of deductions assessed against the Design Paper and can appeal the deductions prior to the end of the competition. Section 13.7 provides further details regarding the appeal process.



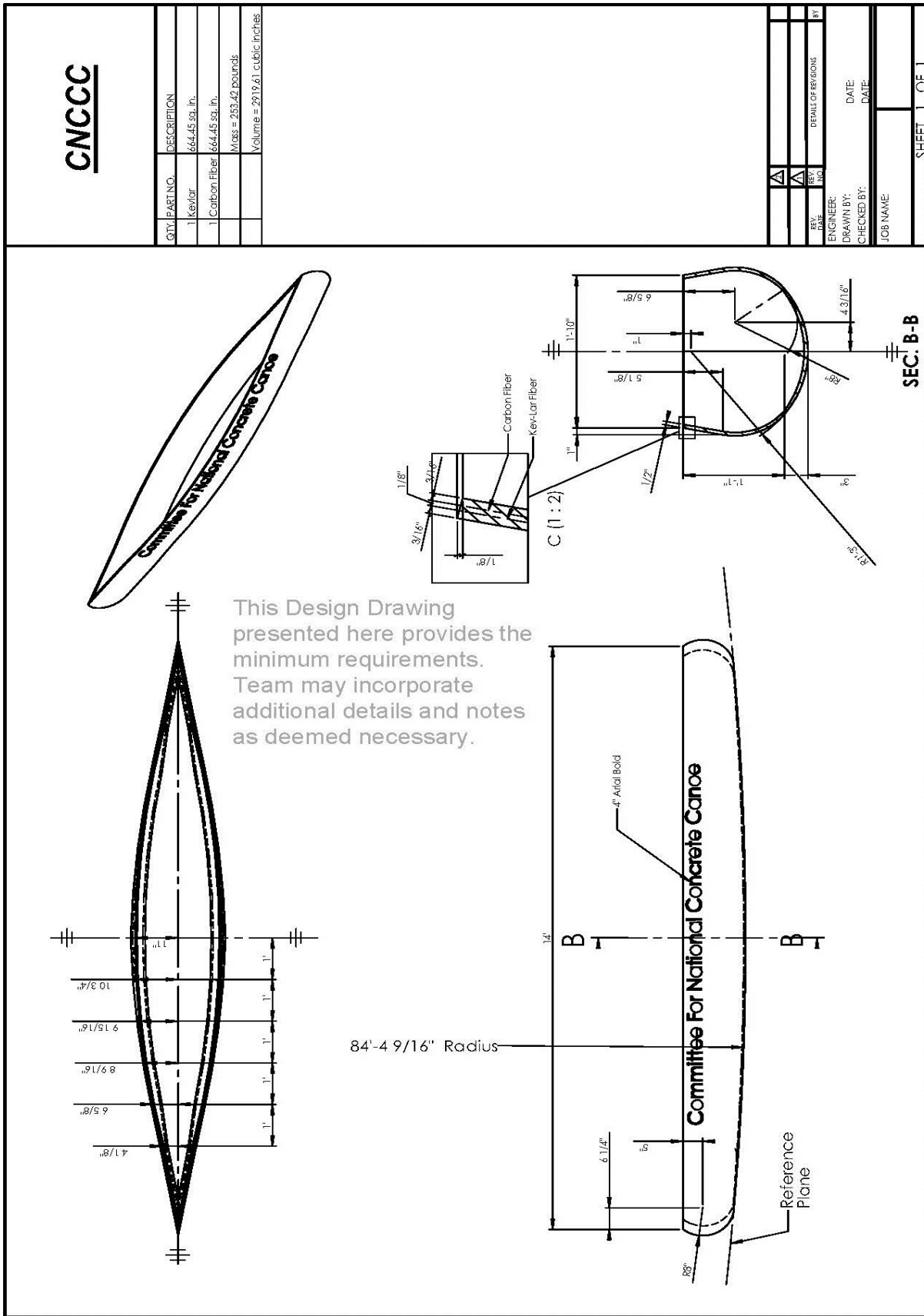

Figure 6.1 – Construction Drawing and Bill of Materials (11 x 17)

## Section 7 – PROJECT OVERVIEW AND TECHNICAL ADDENDUM

**CNCCC Intent** – The intent of this section is to provide the specifications for the Project Overview and Technical Addendum (POTA). In general, the Project Overview and Technical Addendum is intended to serve as a technical document, which contains supportive information related to the design and construction of the canoe. In addition, a Compliance Certificate is provided to certify eligibility of registered participants and provide pertinent information regarding the canoe and concrete.

### 7.0 GENERAL

The *Project Overview and Technical Addendum* (POTA) is a technical document which contains supportive information related to the design and construction of the canoe including photographs of the various stages of construction and technical data sheets of the products used in the canoe.

### 7.1 REFERENCES

The publications listed below form part of this specification to the extent referenced. The latest version of each standard shall govern wherever referenced. The publications are referred to in the text by basic designation only.

ASTM C39	Standard Test Method for Compressive Strength of Cylindrical Concrete Specimens
ASTM C109	Standard Test Method for Compressive Strength of Hydraulic Cement Mortars (Using 2 in. or [50 mm]) Cube Specimens
ASTM C138/C138M	Standard Test Method for Density (Unit Weight), Yield, and Air Content (Gravimetric) of Concrete
ASTM C496	Standard Test Method for Splitting Tensile Strength of Cylindrical Concrete Specimens

### 7.2 General Requirements

Each team shall provide one (1) electronic copy and one (1) hard copy of the *Project Overview and Technical Addendum*. The electronic copy is to be submitted (uploaded) along with the Design Paper at the required competition deadlines. The hard copy is to be presented along with the Design Paper as part of the Final Product Display. The *Project Overview and Technical Addendum* shall contain only the information and documentation as outlined herein. All pages shall be 8 ½ in. by 11 in. with tabs (separators) and contained within a three-ring binder.

A sample *Project Overview and Technical Addendum* can be viewed on the ASCE Concrete Canoe website's rules page (<http://www.asce.org/rules-and-regulations/>)

#### 7.2.1 Format

The electronic copy shall be one (1) complete PDF document that includes bookmarks to the Table of Contents, Compliance Certificate, "How-To", and each individual MTDS. The bookmarks for the MTDS shall be named such that they include the tab number and the product name and/or type of product (i.e.: C-5: ADVA® Cast 575 (HRWR))

The following materials in the following order shall be provided:

- a. **Cover Page**
- b. **Table of Contents** (include school name and canoe name at the top of the sheet)
- c. **Tab A – Compliance Certificate:** Provide one (1) signed *Compliance Certificate*, limited to one (1) single-sided page. The certification shall be presented on an 8 ½ in. by 11 in. page in either portrait or landscape orientation. There are no margin requirements. Body text shall be in English and use 10- or 12-point, normal width, Times New Roman or Arial font. Any headings and subheadings may be of any font type or size. The following must be included at the minimum:
  - 1) School Name and Canoe Name
  - 2) A statement certifying at a minimum that:
    - i. the construction and finishing of the canoe has been performed in complete compliance with the Rules and Regulations of the National Competition;
    - ii. the registered participants at the Conference/National Competition are qualified student members and National Student Members of ASCE, and meet all eligibility requirements;
    - iii. the canoe has been completely built within the current academic year;
    - iv. the team acknowledges all Material Technical Data Sheets (MTDS) and Safety Data Sheets (SDS) have been read by the team, and
    - v. the team acknowledges receipt of the Request for Information (RFI) Summary and that their entry complies with responses provided.
  - 3) The names and ASCE National Member ID Numbers of all registered participants.
  - 4) A table summarizing the following dimensions and parameters of the canoe and concrete:
    - i. maximum length, maximum width, maximum depth, average thickness, and overall weight of the canoe
    - ii. concrete density(ies) including both the wet (plastic) and oven-dried unit weights, concrete compressive strength(s), concrete tensile strength(s), concrete composite flexural strength(s), concrete slump(s)/spread(s), and concrete air content(s)
  - 5) All canoe dimensions are to be reported in feet and/or inches. The weight of the canoe shall be rounded to the nearest pound. Concrete densities and strengths shall be reported in English units to the accuracies outlined in the industry standards (e.g., ASTM C39, C138, C109 and C496, etc.). Specifically, the strength shall be reported to the nearest 10 psi. The density of the hardened concrete shall be reported to the nearest 1 lb/ft<sup>3</sup> and the density of fresh concrete to the nearest 0.1 lb/ft<sup>3</sup>. Slump(s)/spread(s) shall be reported to the nearest ¼ in. Air content should be reported to the nearest 0.1%. The day of testing (i.e., 7-day, 28-day, etc.) shall also be noted.

*Note: The weight of the canoe and the unit weight of the concrete listed on the Compliance Certificate are taken as the official weight and unit weight reported by the team. It is this information that is compared to the value recorded at the National Competition.*

- 6) **Shall be signed and dated by at least one (1) team captain and one (1) Faculty Advisor certifying that the information is valid.** The phone number and e-mail address for both the team captain and the faculty advisor shall be provided.
- d. **Tab B – “How To”:** Convey information on how the team constructed their mold and canoe. The goal is to provide a “notebook” on the Product Display Table for the display viewer and for future teams a “How To” for building a concrete canoe. This shall be accomplished with a total of up to forty (40) photographs and **descriptions** that illustrate the process of the design, research and development (mixture and construction techniques), planning, and physical construction of the mold and concrete canoe. Photographs shall be limited to a maximum of two (2) per single sided page.

At a minimum, the following breakdown of photographs shall be used:

- 1) At least ten (10) of mold construction showing the fabrication of cross sections, assembly of the mold and the application of any coatings prior to canoe construction.
- 2) At least ten (10) of canoe construction showing concrete placement, reinforcement installation and if applicable, flotation placement.
- 3) At least ten (10) of finishing techniques depicting any sanding/patching and the application of sealer and/or graphics.

*Note: Outside of the above requirements, the remaining/additional photographs can be of things such as, but not limited to mix design testing/research, hull design research/testing, product display construction, structural analysis testing/research, etc. The idea for this section is to be able to take the entire notebook and can hand it off to future teams at the school to build off of and learn from.*

- e. **Tab C – Material Technical Data Sheets (MTDS):** Present MTDS for each of the materials used in the construction of the canoe, including but not limited to binders, aggregate, chemical admixtures, reinforcement, and sealers. Originals or photocopies are acceptable. **Please note the Material Technical Data Sheet related to products is not the same as a Safety Data Sheet (SDS).**

The MTDS must provide **current** information clearly verifying that the materials used in the canoe comply with all the specifications (ex: a cement MTDS should show compliance with the applicable ASTM outlined in the rules). **If there are multiple different products on a MTDS, circle, highlight, or identify which product is being used.** In the event the information is not provided (such as proprietary reasons), a letter from the company certifying that the materials used follow the specifications shall suffice, and shall be submitted to the CNCCC for its review and approval, prior to its inclusion in the *Project Overview and Technical Addendum*. The letter shall be on company letterhead, state the specification being verified, and include name, title, phone number, and e-mail address of the individual(s) certifying compliance.

For ease of review, it is recommended that tabs shall be provided for each material that a MTDS is being provided for labeled as C-1, C-2, C-3, etc., as appropriate (for example, C-1 Blast Furnace Slag, C-2 Class C Fly Ash, etc.).

## Section 8 – ORAL PRESENTATION

**CNCCC Intent** – *The intent of this section is to highlight the details of the Oral Presentation. In general, each team is to conduct a live, five (5) minute technical presentation highlighting the various aspects of the project followed by a seven (7) minute question and answer period. The presentation can be made by any of the ten (10) registered participants. Presenters include those with speaking parts, and individuals operating the computer or projectors during the course of the presentation.*

### 8.0 GENERAL

An oral presentation (maximum of 5 minutes, 5 seconds) shall be required for each participating school. The five seconds is a grace period to account for timer (stopwatch) reaction. All presentations shall be conducted in a professional manner (defined as a presentation that a professional engineer would give to a prospective client). Oral presentations shall be presented in English. Presentation order shall be randomly selected before the competition begins and shall be provided no later than the time of on-site registration. The oral presentations, including the question and answer period, shall be open to the public for viewing.

An additional seven (7) minute period shall be permitted for judges' questions immediately following the oral presentation. Questions are not to be permitted by members of the audience. The time required to set up equipment shall not exceed four (4) additional minutes for each school and the time required to take down shall not exceed four (4) minutes for each school.

### 8.1 EQUIPMENT

The host school shall provide two (2) grounded power plugs, two (2) projection screens, and one (1) computer projection unit for general use during the Oral Presentation. The host school shall provide a stage diagram two (2) weeks prior to the competition. Access to the staging area may be limited. The ability to use props may be limited by this restricted access. The individual school making a presentation shall furnish any additional equipment necessary.

### 8.2 PRESENTERS

Presenters may be any of the registered participants who officially sign-in at registration (Section 1.2). Presenters include those with speaking parts and individuals operating the computer or projectors. **A minimum of two (2) people must speak during the live presentation.**

Teams shall make a live presentation. The use of video shall be permitted. Teams shall not pre-record any speaking parts. No handouts or other materials shall be given to the judges as part of the oral presentation. All team members participating in the presentation shall be on stage and available for judge's questions.

### 8.3 DEDUCTIONS

Deductions will be assessed for infringements of the specifications, including but not limited to, exceeding the official time limit of 5 minutes 5 seconds (5:05), including sponsorship information (see Section 1.5) and not following the live presentation format.

## Section 9 – FINAL PRODUCT (Canoe and Cutaway Section)

**CNCCC Intent** – *The intent of this section is to (a) describe the various aspects of Final Product judging and (b) provide guidance to the judges on the criteria for their assessments. The Final Product is based on scores assigned by the judges on the canoe’s overall aesthetic appeal and deductions for items such as the inability to pass the flotation test on the first attempt, the use of tape as a repair material for non-accident related damage, and non-compliance with the rules and regulations*

### 9.0 GENERAL

The Final Product (canoe, cutaway section and product display) shall be consistent with the Design Report and Oral Presentation. Final Product assessment consists of assigning a score based on the canoe’s overall aesthetic appeal and applying deductions based on the inability to pass the flotation test, the use of tape as a repair material for non-accident related damage, and non-compliance with the Rules and Regulations. Canoe durability is based on the use of tape as a repair material and the canoe’s ability to complete the required events. Durability is assessed by the judges at the Conference Competition and by the judges and/or CNCCC at the National Competition.

### 9.1 AESTHETICS

#### 9.1.1 General Requirements

Judging shall assess the aesthetic appeal of the “as-built, as-delivered” product. At the time of judging, gunwale caps and coverings shall be removed. Aesthetics judging may take place before or after the canoe has been certified as passing the flotation test. If judging takes place after the flotation test, teams that required additional flotation to pass the test may temporarily remove the added flotation to be judged. After judging has been concluded, the teams shall place the flotation back in its original position.

Any flotation added at the Conference Competition to pass the flotation test shall remain in place for the National Competition. At the National Competition, the canoe with its added flotation shall be considered “as built, as delivered” and judged accordingly.

For aesthetics judging, all canoes shall be assembled in a common area. Canoes shall be displayed on display stands designed to support the canoe at a height of 3 to 4 feet off the ground. No lighting, sound, or canopies shall be permitted at the time of judging.

#### 9.1.2 Judging Criteria

The judges shall assess the aesthetics/workmanship of a canoe, cutaway section, and product display (Section 10) based on his/her own criteria, but in accordance with the Final Product score sheet (Appendix A-3).

#### 9.1.3 Scoring

Prior to aesthetics judging, each judge will receive a rating sheet that lists each canoe in the competition (Appendix A-3). For each canoe in the competition, there shall be one (1) aesthetics score from each judge. Completed sheets are to be turned in to the appropriate competition official at the end of aesthetics judging. Any attempt to influence the votes of the judges is not allowed and is cause for disqualification and immediate dismissal from the event. Judges’ decisions regarding this are final and may not be appealed.

## 9.2 DURABILITY

### 9.2.1 General Requirements

Canoes should be tough enough to survive the rigors of the Conference Competition, the National Competition, and transportation to and from the various events.

### 9.2.2 Deductions

The following is the list of standard deductions that can be implemented for durability issues:

- a. **If a tape repair is required to continue racing for reasons other than those outlined in Section 9.2.3, “Limitations,” an automatic 25-point deduction is assessed.**
- b. **Failure of the canoe to attempt / complete all preliminary sprint and endurance events will result in zero Final Product points.** All races must be attempted with a “good faith” effort as to not be disqualified and receive zero points. A “Did Not Finish” (DNF) does not result in zero Final Product points (Section 11.5).
- c. **The use of materials other than tape will result in the team automatically receiving zero Final Product points.** If a team uses materials other than tape to repair their canoe to continue racing for fun, the team will not receive any points for races completed after that repair has been made.

### 9.2.3 Limitations

If the damage to the canoe occurs due to a collision, deductions for the use of tape shall not be assessed against a team. In the event of damage resulting from a collision, the team must first file a *Damage/Accident Report* (Appendix B-3) with the judges or CNCCC and must receive written approval before any tape can be applied. This applies to all instances that tape will be added (that is, permission to use tape to repair damage in one location does not give the team the freedom to put tape elsewhere; permission is needed for each instance).

Deductions do not apply to the tape used to secure a gunwale cover or added to secure flotation material necessary to pass the flotation test.

## 9.3 CUTAWAY SECTION

A full-scale cutaway model section **representative** of both the raw and finished canoe shall be judged as part of the Final Product and shall be presented alongside the canoe. At least three (3) feet of the cutaway section shall demonstrate the concrete casting, finishing, and reinforcement techniques used (i.e., the three-foot section should show concrete placement and finishing in various stages). The cutaway section shall also show the mold; however, it does not count towards the required length of the cutaway section. No additional pictures or text shall be included except for labels properly identifying specific construction elements of the cutaway section. No artistic enhancements are permitted.

## 9.4 FINAL PRODUCT DEDUCTIONS

Deductions for Final Product are based on durability issues, failure to pass the flotation test, repairs and reconstruction, and non-compliance with these Rules and Regulations.

## Section 10 – PRODUCT DISPLAY

**CNCCC Intent** – The intent of this section is to describe what items are required for the Product Display. In general, teams shall provide the following: tabletop display, concrete cylinder(s), sample(s) of concrete aggregate(s), bill of materials, job safety analysis, seats and/or mats, and hard copies of the Design Paper and Project Overview and Technical Addendum.

### 10.0 GENERAL

Each team shall provide a Product Display with the following configuration:

- a. *Conference Table* – standard table, with maximum dimensions of 30” (W) x 96” (L) x 29” (H). Each team shall provide their own table (may include a solid color table cloth). The table shall be of the type commonly available for purchase and shall not be custom built for your display.
- b. *Table Top Display* – the tabletop display, including overhangs, projections, and braces, shall fall wholly within a 30” (W) x 96” (L) x 48” (H) box. The tabletop display shall be placed on the table and provide enough space to accommodate all information and samples. It will only be viewed from only one side that opens to the front of the table.



### 10.1 REQUIRED INFORMATION AND SAMPLES

The tabletop display shall:

- a. Present graphs, tables, figures, or other graphics to depict project management and QA/QC information. This can include items such as person hour allocation, budgetary figures (i.e.: budget allocation, projection, comparisons to previous year(s), etc.), safety program, QA/QC flow chart, etc. Brief captions may be included. See Figure 10.1 for some examples for these graphics.
- b. Have the following provided as part of the display:
  - Individual sample(s) of concrete aggregate, 500 mL (min.) (Section 3.4.4)
  - Composite sample(s) of concrete aggregate, 500 mL (min.) (Section 3.4.4)
  - Concrete cylinder(s) of each mixture, 3 in. or 4 in. diameter, split in two halves (Section 3.4.5)
  - Raw reinforcement samples (Section 4.4.1)
  - One (1) hard-copy of Design Paper (Section 6)
  - One (1) hard-copy of the *Project Overview and Technical Addendum* (Section 7)

Have the following, readily available for compliance checking

- Seats/mats for measurement check (Section 2.6)
  - Concrete cylinder(s) of each concrete mixture, 3 in. or 4 in. diameter in oven-dried condition, for unit weight verification (Section 3.4.5)
- c. Provide a bill of materials (BOM) and production cost estimate. The BOM shall list the name, quantity, unit price (market price if donated), and total cost of each material used for the construction of the canoe. Materials should include, but are not limited to binding material(s), aggregate(s), admixtures(s), fibers(s), reinforcement, sealers, flotation material, and lettering.



## PROJECT MANAGEMENT RESOURCE ALLOCATION

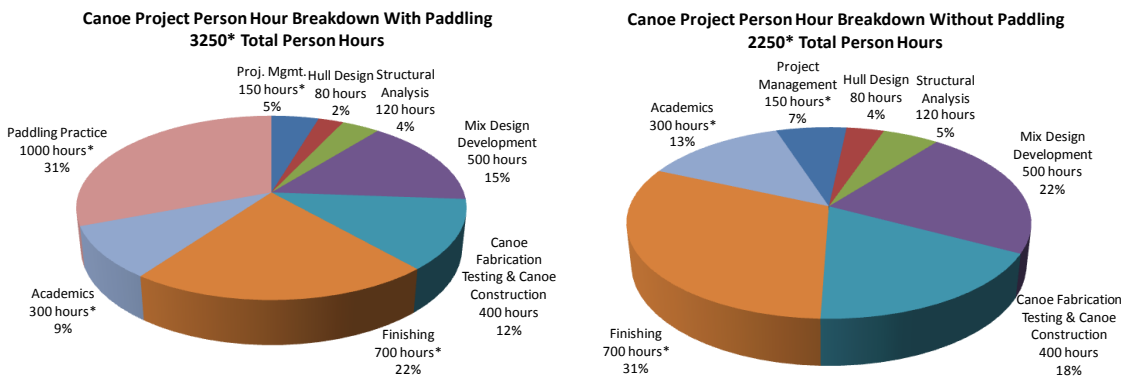
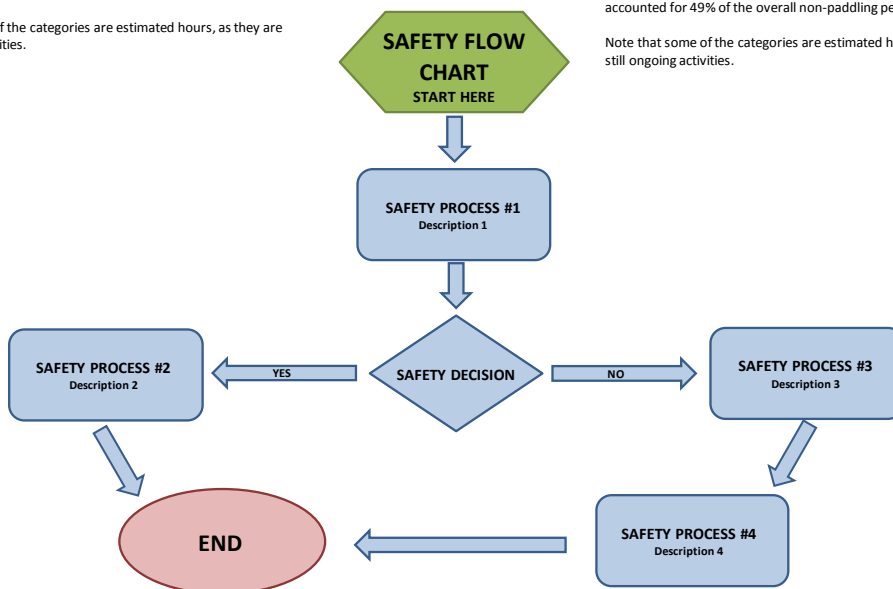

**Figure 1: Person Hours with Paddling** - The person hour breakdown shows the distribution of all of the 3250 person hours for the project. By including paddling practice, it accounts for nearly 1/3 of the overall person hours.

**Figure 2: Person Hours without Paddling** - The person hour breakdown shows the distribution of all of the non-paddling practice person hours. The Construction Team related activities (Finishing and Canoe Fabrication Testing & Canoe Construction) accounted for 49% of the overall non-paddling person hours.

Note that some of the categories are estimated hours, as they are still ongoing activities.

Note that some of the categories are estimated hours, as they are still ongoing activities.



**Figure 3: Safety Flow Chart** - The above flow chart depicts the safety process used while using and handling all of the various mix design components to ensure a safe working environment.

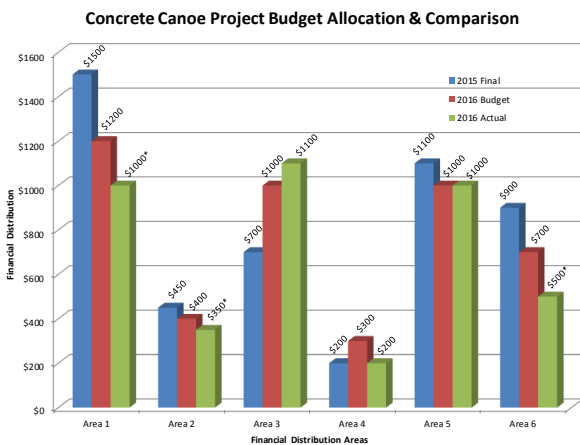

**Figure 4: Project Budget Allocation & Comparison** - The Project Management team used the 2015 Final Budget as a guideline while determining the 2016 Budget. Note there are a few areas that are estimated 2016 Actual budgetary numbers, as these areas still have ongoing expenses.

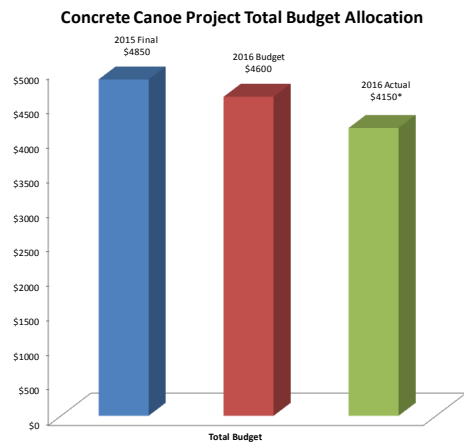

**Figure 5: Project Total Budget Allocation** - In an effort to try and limit expenditures, the team's overall budget was reduced from the 2015 Final expenditures. The 2016 Actual expenditures is currently estimated to come in under budget by approximately 15% from last year's expenses.

\* indicates estimate

Figure 10.1 – Example Graphics for Final Product Display

A lump sum cost shall be provided for the mold used in the construction of the canoe. Notes can be provided indicating that the cost covers materials such as lumber, hardware (screws, nails, etc.), foam, fiberglass, gel and epoxy coats, etc. as applicable. A detailed itemization (such as number of screws or lengths of lumber) is not to be provided.

Costs associated with engineering, testing, construction (labor and equipment), prototypes, etc. are not to be included in the cost of the material or be provided as a separate item. Unit prices should not include any mark-up or overhead and profit.

An example of a Bill of Material table is provided in Table 10.1. Teams may format the table as appropriate.

- d. A safety analysis of one task completed during the construction of your canoe or mold is required to be displayed on your final product display. See Appendix “D” for the Job Hazard Analysis Form that is to be filled out and displayed.

**Table 10.1 – Bill of Materials and Production Cost Estimate (Example)**

Material	Quantity	Unit Cost	Total Price
Portland Cement, Type III	lbs	\$/lbs	\$
Fly Ash, Class C	lbs	\$/lbs	\$
Slag, Grade 120	lbs	\$/lbs	\$
Aggregate A	lbs	\$/lbs	\$
Aggregate B	lbs	\$/lbs	\$
Welded Wire Mesh	sq. ft.	\$/sq. ft.	\$
Vinyl Lettering	Lump Sum	\$	\$
Sealer	gal.	\$/gal	\$
Wooden Mold, complete	Lump Sum	\$	\$
<b>Total Production Cost</b>			<b>\$</b>

**10.2 RESTRICTIONS**

- a. Displays must be designed to be self-supporting and may be secured to the table. Nothing shall be taped, mounted or attached in any form or manner to the walls, doors, or floors, etc.
- b. Displays shall not include electronic devices (such as, but not limited to, laptops, lighting, sound or video equipment, radios, loudspeakers or any other noise-creating devices).
- c. No sponsor-related items (such as sponsor list, logos, etc.) shall be part of the display.

**10.3 DEDUCTIONS**

Any product display that is not in compliance with this section shall be subject to a deduction in Final Product.

## Section 11 – RACE RULES and REGULATIONS

### 11.0 GENERAL

A total of five (5) races shall typically be held: women's endurance (2 women), men's endurance (2 men), women's sprint (2 women), men's sprint (2 men), and co-ed sprint (2 men and 2 women).

### 11.1 RACE RULES

The following general rules apply to the paddlers:

- a. Good faith efforts are made to start and finish all races. Should issues arise that may compromise the structural integrity of the canoe or the safety of the paddlers, teams must exercise good judgment in determining the best course of action (ensuring safety and maintaining structural integrity; not attempting to circumvent the Rules on technicalities). Head Judges are to be advised of all issues that arise (such as structural damage) in a timely manner so that they are aware of the situation and knowledgeable of the course of action to be undertaken.
- b. Teams shall use the same individuals in both the preliminary and final heats of any race.
- c. If a paddler is injured prior to a preliminary race, a substitution may be made. This substitute paddler shall be one of the original five (5) of the same gender registered on the team.
- d. In the event of an injury that prevents a paddler from further competition after the preliminary race has been completed, the injured person or a substitute shall be in the canoe in subsequent races. However, this person or these persons shall not be allowed to paddle. The substitute passenger shall be one of the original five (5) of the same gender registered on the team.
- e. If a team cannot field the proper number of paddlers of the required gender, substitute passengers of opposite gender shall be allowed, but these substitutes shall not be allowed to paddle. Substitute passengers shall be of the team's registered participants.

Teams competing in the distance races shall compete against the clock in a timed single event. All other races shall include timed preliminaries and finals. The top five canoes advance to the grand final and the next five canoes advance to the petite final based on qualifying times in the preliminaries, grand final and a petite final based on the top ten (10) qualifying times from the preliminaries. Points shall be awarded based on the finish times in the finals. If finals cannot be conducted or the host school determines before the race competition starts that separate finals heats will not be run; the preliminary times shall be used as the final times. For all sprint races, if a team qualifies for a final event but cannot start an event, that team does not receive points and the team's slot is conceded to the team with the next best preliminary sprint time. For final sprint races, if a team starts a race in a canoe deemed race-worthy by the judges, but is unable to complete the race, they are awarded the points corresponding to completing the race last in their final.

In a situation where all the race events cannot be conducted (for example, the distance races were completed but the sprint races could not be completed), the race scores (Section 13.4) for

all of the completed races shall be accounted for in the overall competition score. By no means should the race scores be adjusted to account for races not held/completed.

In a situation where none of the race events can take place, the overall competition score shall be based solely on the results of the academic portion of the competition (Design Paper, Oral Presentation, and Final Product) with the maximum possible score being 75 points.

### 11.1.1 Conference Competitions

Depending on the number of entrants at the conference competitions, host schools shall decide on having grand and petite finals for the various sprint races. The host school shall inform all teams prior to the competition if both preliminaries and finals will be held or if the sprint races will be based on the best times in the preliminaries.

### 11.1.2 Lane Position and Heat Assignments

Lane position and heat assignments shall be randomly selected before the competition begins and shall be provided at registration. Course and turn directions shall be announced as soon as they can be determined by the course layout and site conditions. The conference and national host schools shall provide a diagram or map to the participants outlining the layout of the course prior to the races.

### 11.1.3 Sportsmanship

Commonly accepted rules of sportsmanship shall prevail. There shall be strict enforcement of racing etiquette by the CNCCC and the judges. Any canoe willfully interfering with the performance of any other canoe or participant in a race shall be automatically disqualified. Any use of paddles to intentionally strike at an opponent's canoe, or at any person, shall be cause of disqualification of the offending team from the event. Good sportsmanship, cooperation, fellowship, and the spirit of competition shall be strictly adhered to.

Spectators interfering with the performance of contestants shall be asked to leave and may cause the disqualification of affiliated contestants. Contestants or spectators interfering with the performance of the competition, judges' ruling, or protests, may cause the disqualification of the affiliated school.

### 11.1.4 Interference

**In situations where there is lane interference and/or when canoes collide, paddlers must immediately STOP, hold paddles above their heads and discontinue racing.** If interference occurs at the Conference Competition, the team captain shall appeal directly to the head judge. During the National Competition, a team captain will make their appeal to the appointed CNCCC member who will confer with the judges. Once presented with the appeal, the judges shall:

- a. Disqualify a team that has willfully interfered with another team. (If the interference is not deliberate, then the team should not be disqualified).
- b. Disqualify a team that willfully fails to adhere to course boundaries resulting in interference with another canoe. (If the interference is not deliberate, then the team should not be disqualified).
- c. Allow any team(s) directly affected by interference the option to rerun the heat in a timed event. Times from the rerunning of the heat shall be used as the official time for the heat.

Heats shall be rerun after a minimum of ten (10) minutes to allow paddlers to prepare themselves.

**If paddlers fail to immediately stop, raise paddles and continue to race, they cannot claim interference and will not be granted an opportunity to rerun their race.**

### 11.1.5 Appeals

Requests for rule interpretations and/or appeals during Conference Competition shall be presented to the Conference Head Judge by the designated team captain(s). Requests for rule interpretations and/or appeals during the National Competition shall be presented to the CNCCC by the designated team captain(s). Such request or appeals must be lodged before the start of the next heat or in the case of the distance races, before the next three (3) canoes finish the race. Appeals shall be made by a team captain. The decisions made by the judges and/or CNCCC concerning all aspects of the race and judging shall be final. Conference head judges may contact the CNCCC to clarify rule interpretations and to discuss appeals that have been lodged by team captains.

## 11.2 SAFETY

### 11.2.1 Safety Guidelines

**Participant safety is always the first priority.** When scheduling and planning the races, consider all safety hazards, depending on location and circumstances, plan accordingly to mitigate them and decide what conditions would cause races to be cancelled. Each competition host has the authority to require safety equipment or procedures beyond the general requirements established for the National Competition. The recommendations below identify many common hazards, but not all eventualities are covered. It is strongly recommended that each hosting site perform a comprehensive evaluation of specific hazards and develop their own safety plan.

*In addition, equivalent safety procedures should be used during team practices in the weeks and months prior to the canoe races. Multiple boats should always be used when there is cold or rough water risk, such that swamped paddlers will not be in the water for more than a few minutes. Consider installing additional flotation such as air bags or foam for practice boats as well.*

**Cold water** can cause impaired judgment, loss of coordination and hypothermia within minutes. Paddlers, already excited about the races, may make unreasonably poor decisions when cold and becoming hypothermic. The American Canoe Association (reference below) recommends wetsuits for water temperatures less than 60°F and/or if the combined air and water temperatures are less than 120°F. Consider requiring wetsuits (full-body, sleeveless, or shortie depending on severity) and more safety boats to get paddlers out of the water quickly.

**Wind and waves, currents, obstruction and other rough water** can more easily swamp and break canoes. Carefully evaluate the proposed race site during a variety of weather conditions to have a good sense for how the water behaves. Depending on seasonal weather conditions, water may be higher or lower. For the canoes, consider requiring integrated grab handles, provisions for tied-in air bags (common flotation for whitewater canoes), and more stringent flotation requirements. Just like cold water, more safety boats may be required.

**Hazardous wildlife** in and out of the water can cause anything from skin irritations and allergic reactions to more serious lacerations. Be sure to alert participants and monitor activities carefully.

**Lightning and storms** are also very dangerous. Monitor the weather and remove everyone from the water when lightning and/or strong storms threaten.

### 11.2.2 Powered Rescue Boat

**At least one and preferably two powered rescue boats shall be on the water during all the races. If a powered rescue boat is not available, the races shall not take place.** Consider having more powered (or non-powered) safety boats with competent operators for paddler assistance. In many circumstances, having another boat to stabilize and assist a swamped canoe until a larger powered rescue boat can retrieve them is very helpful. Occasionally more than one canoe at a time needs assistance as well.

### 11.2.3 Safety Director

A safety director shall be in a strategic position to observe the activities, especially those near the starting and docking area. The safety director is responsible for stopping all activities involving violations of any of the safety rules.

In addition, the safety director is responsible for briefing paddlers on all known hazards prior to any paddling or racing, and as conditions warrant throughout the race competition.

### 11.2.4 Canoe Safety

All canoes shall be able to pass a flotation test before entry in the races (Section 2.10.2); otherwise, it shall not be permitted to compete. If flotation materials are necessary to pass the flotation test, the canoe shall contain the same flotation materials during the race (Section 2.10.3).

Any entry deemed unsafe or hazardous by the judges shall not be permitted in the water unless corrective measures are taken. If corrective measures are not or cannot be made the entry shall be disqualified from further competition. If repairs must be made to an entry prior to any race, the judges may allow the entry to reschedule for a later heat, but prior to the next event.

### 11.2.5 Paddler Safety

All paddlers shall be competent swimmers. All Paddlers shall wear a US Coast Guard-approved inherently buoyant (no inflatables) Type I, II or III Personal Flotation Device (life jacket) always while in a canoe during competition and/or practice. Wet suit buoyancy pads shall not be used as a substitute for the Coast Guard approved Personal Flotation Device. Based on the guidelines in (Section 11.2.1) above, additional requirements may be added as appropriate. Containers or objects not required for safe operations shall not be permitted in canoes.

### 11.2.6 Additional Safety References

Following are a couple references to documents from the American Canoe Association ([www.americancanoe.org](http://www.americancanoe.org)) for further reading and planning race day safety.

American Canoe Association (2014). Best Practices for Paddlers and Paddlesport Programs [PDF document] URL

[http://c.ymcdn.com/sites/www.americancanoe.org/resource/resmgr/sei-educational\\_resources/brochure\\_best\\_practices.pdf](http://c.ymcdn.com/sites/www.americancanoe.org/resource/resmgr/sei-educational_resources/brochure_best_practices.pdf).

American Canoe Association (2014). Cold Water Survival [PDF document] [http://c.ymcdn.com/sites/www.americancanoe.org/resource/resmgr/sei-educational\\_resources/brochure\\_cold\\_water\\_survival.pdf](http://c.ymcdn.com/sites/www.americancanoe.org/resource/resmgr/sei-educational_resources/brochure_cold_water_survival.pdf).

## 11.3 RACE COURSE

### 11.3.1 General Requirements

The bow of the canoe shall remain the bow of the canoe throughout each race in consideration of a successful negotiation of a turn or finish buoy.

Different colored buoys shall mark the racecourse lanes. The Endurance and Sprint courses must meet the alignment, distance, spacing, and turns as noted in Sections 11.3.2 and 11.3.3, respectively. Figure 11.1 and Figure 11.2 provide recommended course layouts; however, these are subject to site-specific conditions and limitations.

### 11.3.2 600-meter Endurance Course

The endurance course shall consist of the following subject to site conditions:

- a. A total of 600 meters in distance with a minimum of two (2) turns.
- b. At Conference Competitions, the course shall begin with a slalom course consisting of seven (7) buoys. Each slalom buoy shall be staggered 5 meters transversely from each other. Buoys shall be longitudinally spaced at 10 meters with 20 meters between the third and fourth buoy.
- c. At the National Competition, the CNCCC reserves the right to modify the location and layout of the slalom portion of the course.

### 11.3.3 200- and 400-meter Sprint Course

A sprint course shall consist of the following subject to site conditions:

- a. The men's and women's sprint course will be a 200-meter race consisting of a straight course 100 meters out, a 180° turn, and 100 meters back.
- b. The co-ed race will be a 400-meter race and shall consist of two (2) laps of the sprint course.
- c. Lanes shall be no narrower than 15 meters.

## 11.4 RACE PENALTIES

A buoy is successfully negotiated when the entire canoe passes on the proper side of the buoy. A canoe may touch a buoy but the top of the buoy must stay above the waterline on the proper side of the canoe until the canoe has entirely passed. A canoe's time shall not be considered final until all buoys have been properly negotiated. The following corresponding penalties shall be assessed as defined below:

- a. A canoe that crosses the finish line in the wrong lane shall be assessed a 30-second time penalty for that event.

- b. All turn buoys must be properly negotiated or the team shall be disqualified for that event. Teams must properly negotiate all turn buoys in the endurance race. A sprint turn must be negotiated within the assigned lane. A 30-second time penalty will be assessed for each missed slalom buoy. All slalom buoys must be attempted. If a team chose to simply bypass the buoys to save time they will receive a DNF (Section 11.5) and zero (0) points for that race.
- c. For a team to successfully finish a given race, the bow of the canoe must cross the finish line with the same number of paddlers (in the canoe or touching the canoe) with which the race began.
- d. Safety officials reserve the right to use their best judgment to remove a swamped canoe and paddlers from the racecourse if the situation warrants.

## 11.5 DID NOT FINISH (DNF)

If a canoe cannot complete a given race but is found to be seaworthy enough to continue to compete (a typical example is when a canoe becomes submerged during a race), then the team will be given a “Did Not Finish” (DNF) for that race. A DNF shall also be applied as defined in Section 11.4.b. There may be other circumstances not outlined within these Rules and Regulations where a DNF may be applicable. Judges shall contact the CNCCC to determine whether a DNF should be applied.

**Seaworthiness** is defined by a canoe that has (1) little to no structural damage or (2) structural damage that has been sufficiently repaired to the judge’s and/or the CNCCC’s satisfaction regarding safety and subjected to another flotation test. If damage occurred in the last race event of the day for the team, the seaworthiness of the canoe must still be demonstrated. If repairs to the canoe are needed to demonstrate seaworthiness, they must be made by the team.

DNF results in zero points for a given race. It does not result in zero (0) points in Final Product.



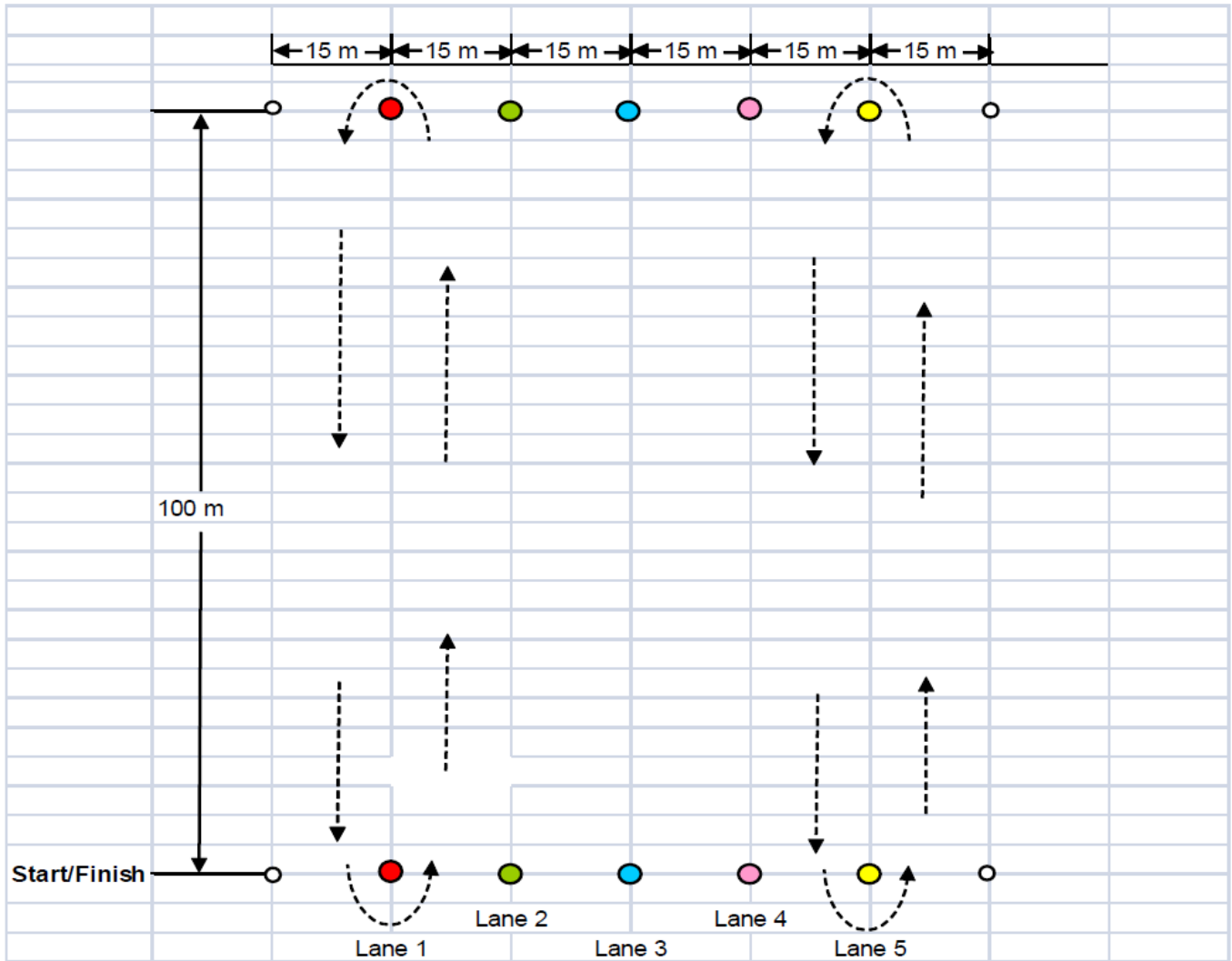

**Note:** Figure above depicts that canoes must go up one lane and upon negotiating the turning buoy will go down the lane directly next to it (i.e., a canoe should not finish the race in the same lane it started in.)

**Figure 11.1 – Sprint Race Course Layout**

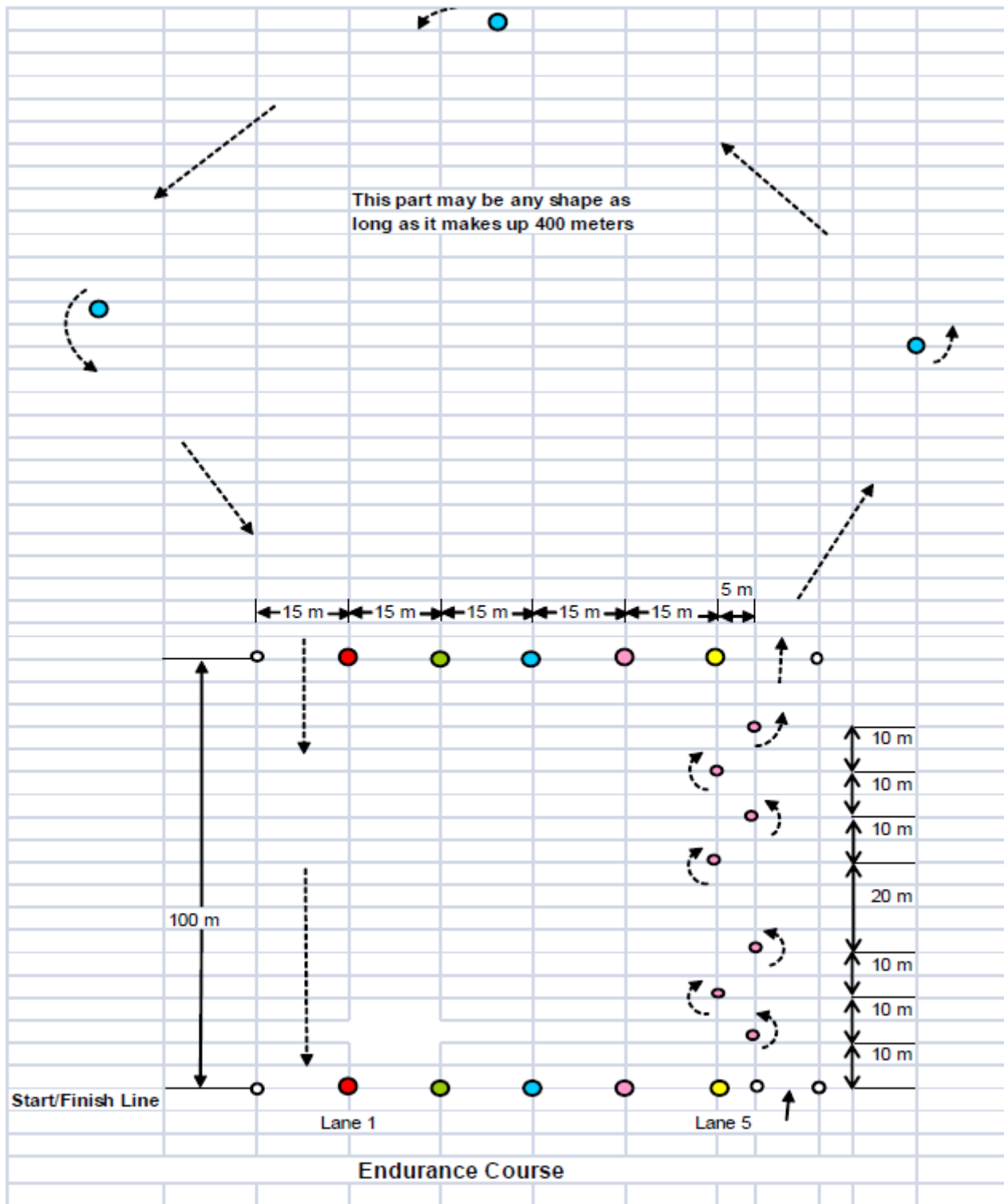

Figure 11.2 –Endurance Race Course Layout (Example Layout)

## Section 12 – NATIONAL QUALIFYING RULES

### 12.0 GENERAL

To maintain the competition of the event in addition to creating a more uniform system for national qualification, it shall be mandatory that the Conference Competitions adopt and comply with the following sections applicable to the National Competition:

Section 1 – GENERAL RULES AND ELIGIBILITY REQUIREMENTS; All except Sections 1.3.

Section 2 – CANOE; Section 3 – CONCRETE; Section 4 – REINFORCEMENT; Section 5 – FINISHING; Section 6 – DESIGN PAPER; Section 7 – PROJECT OVERVIEW AND TECHNICAL ADDENDUM ; Section 8 – ORAL PRESENTATION; Section 9 – FINAL PRODUCT; Section 10 – FINAL PRODUCT DISPLAY; Section 11 – RACE RULES AND REGULATIONS; and Section 13 – OVERALL SCORING; All.

### 12.1 APPEAL PROCESS

The Conference Competition judges shall settle all appeals from their competition, decide the Conference Competition winner, and distribute awards based on scores that have been checked and officially ratified by the Conference Head Judge (Section 1.10.1). This is the only formal appeal process available for the Conference Competition.

Section 13.7 covers the appeal process and rule clarification that shall be implemented at the Conference and National Competitions.

**The CNCCC will not entertain any appeals filed by the teams after the Conference Competition nor will they overturn any of the judges' decisions.**

### 12.2 ASCE MEMBERSHIP

Concrete Canoe Competition team members at the Conferences shall be members of an ASCE Student Organization affiliated with their university. Registered participants for the National Concrete Canoe Competition™ shall be ASCE National Student Members with a membership status of “active” and shall provide valid ASCE ID numbers with the submittal of the registration materials. Team members whose memberships are not of active status will not be allowed to participate as registered participants.

## Section 13 – OVERALL SCORING

### 13.0 GENERAL

Scoring for the competition is divided into four (4) events:

Event	Maximum Competition Points
1. Academic Judging - Design Paper	25
2. Academic Judging - Oral Presentations	25
3. Academic Judging - Final Product	25
4. Races (5 races)	25
	100

### 13.1 COMPETITION POINTS FOR ACADEMIC JUDGING

Competition Points for Design Paper, Oral Presentation and Final Product are awarded per *Appendix A – Judges’ Score Sheets*. Deductions assessed for Design Paper, Oral Presentation and Final Product are also provided in Appendix A. For the Design Paper, Oral Presentation and Final Product, the event points for a given judge (i.e. raw score) will result in an independent ranking from 1st to *n*th place (with *n* being equal to the number of teams competing) for each category. The independent rankings of the judges will then be averaged to determine the overall score for the entry. Raw scores will be used in the event of tiebreaker (Section 13.3).

For example, assume a team receives scores of 90, 87, 94, 83, and 90 for the Design Paper which when compared to scores given to other teams by the same judge, results in independent rankings of 2nd, 3rd, 1st, 2nd, and 4th places, respectively. The average ranking will be 2.4. The average ranking of all teams shall then be compared to determine the overall placement in each category.

**An official electronic scoresheet is provided to host schools and shall be used at all Conference Competitions.**

This electronic score sheet will be available on February 17, 2018 at [www.asce.org/concretecanoe](http://www.asce.org/concretecanoe).

#### 13.1.1 Number of Judges

Each event shall be evaluated by a panel of judges. The minimum number of judges for any given event is three (3) and the maximum is five (5). **It is ASCE’s intent that all the competition events are judged by the same panel of judges and by the same number of judges.** The head judge must be available for all aspects of the competition and is required to judge each of the events.

The judges for the Conference Competitions are selected by the conference host school (preferably with assistance from the local ASCE Section or Branch). It is the responsibility of the host school for ensuring that an adequate number of judges are available for the competition.

The judges for the National Competition are selected by ASCE. The national panel will be comprised of five (5) judges, one of which is selected from a previous year’s competition to serve as the returning head judge.

### 13.2 RANKING

Placing for each event shall be determined by the ranking of the overall scores. In the event of a tie, the average of the raw scores will determine the actual placing. If the tie remains after averaging the raw scores, then the tie will remain. Competition points shall be determined by dividing points for the positions involved in the tie. For example, if a second-place tie occurs in the Design Paper event, points for second and third places will be averaged and awarded to the tied teams, if a tie remains after an average of the raw scores. The team with the next highest score will receive points for fourth place.

### 13.3 TIEBREAKER (FINAL OVERALL STANDINGS)

Ties in the final standings for the competition overall shall be broken. In such cases, a tie breaking score, *TBS*, shall be calculated according to the following formula:

$$TBS = \frac{25}{100} \left( \frac{\sum DPP}{NOJ} \right) + \frac{25}{100} \left( \frac{\sum OPP}{NOJ} \right) + \frac{25}{100} \left( \frac{\sum FPP}{NOJ} \right) + RP$$

where: *DPP* = design paper event points for a given judge (Appendix A-1), *OPP* = oral presentation event points for a given judge (Appendix A-2), *FPP* = final product (aesthetics) event points for a given judge (Appendix A-3), *NOJ* = number of judges, and *RP* = unmodified race points. **No judge's score shall be dropped when calculating these points.** The calculation of the *TBS* shall not change the standings for team placement in any given academic scoring part. Of the teams tied for overall winner or overall second place, the team with the highest *TBS* shall be awarded the place in contention.

If a tie still exists for first and/or second place after the tie breaking scores have been determined, then the judges shall determine the overall winner for the competition position. The judges may choose to base their decision on whatever criteria they deem appropriate including but not limited to their subjective evaluation of determination, dedication, sportsmanship, enthusiasm, and overall comportment. The judges' criteria and decision shall be final and may not be appealed.

### 13.4 COMPETITION POINTS

Competition points will be allotted per place according to the following table:

Place	Academic Events			Race Events		
	Design Paper	Oral Pres.	Final Product	Endurance	Men's & Women's Sprints	Coed Sprints
First	25.0	25.0	25.0	5.0	4.5	6.0
Second	22.5	22.5	22.5	4.5	4.0	5.4
Third	20.0	20.0	20.0	4.0	3.6	4.8
Fourth	17.5	17.5	17.5	3.5	3.1	4.2
Fifth	15.0	15.0	15.0	3.0	2.6	3.6
Sixth	12.5	12.5	12.5	2.5	2.2	3.0
Seventh	10.0	10.0	10.0	2.0	1.8	2.4
Eighth	7.5	7.5	7.5	1.5	1.4	1.8
Ninth	5.0	5.0	5.0	1.0	0.9	1.2
Tenth	2.5	2.5	2.5	0.5	0.4	0.6

## 13.5 RACES

For the endurance race, no points are awarded a team that does not finish or does not race. For all sprint races, if a team qualifies for a final event but cannot start an event, that team does not receive points and the team's slot is conceded to the team with the next best preliminary sprint time. For final sprint races, if a team starts a race in a canoe deemed race-worthy by the judges, but is unable to complete the race, they are awarded the points corresponding to completing the race last in their final.

### 13.5.1 No Races Conducted

If none of the race events can take place (bad weather or unsafe racing conditions), the overall competition score shall be based solely on the results of the academic portion of the competition (Design Paper, Oral Presentation, and Final Product) with a maximum possible score of 75 points.

### 13.5.2 Partial Completion of Races

If all the race events cannot be conducted/completed, only the scores for all the completed races (i.e., each school participated in the event) shall be accounted for in the overall competition score. The race scores should not be adjusted to account for the races not conducted/completed.

## 13.6 SUMMARY OF DEDUCTIONS / DISQUALIFICATION

### 13.6.1 General

These deductions may also be referenced in other sections of these rules and regulations and/or the scoring sheets. **It is highly suggested that the judges contact the CNCCC regarding situations that may not be covered in the rules to determine the appropriate course of action.**

### 13.6.2 Disqualification

Teams may be disqualified from the competition for the following:

- a. Failure to follow student eligibility requirements (Section 1.2.1)
- b. Violations under the *Spirit of the Competition* [at the discretion of the CNCCC and/or Judges] (Section 1.9) or under the *Ethics and the Competition* (Section 1.6)
- c. Failure to follow academic year, rebuilding, and material requirements (Sections 2 through 5).
- d. Sportsmanship and interference requirements (Sections 11.1.3 and 11.1.4)
- e. Failure to follow safety rules (Sections 11.2).

### 13.6.3 Standardized Deductions

To ensure fair and consistent judging throughout the Competitions, the deductions are standardized and apply only to the relevant competition event.

## 13.7 APPEAL OF DEDUCTIONS

During the competitions, the judges and/or CNCCC shall inform the team captains about the deductions that have been assessed against their canoe and/or team. The team captains will then be afforded the opportunity to appeal the deductions through a written response that will then be reviewed by the judges. **Designated team captains are the only individuals that may appeal the deductions.** The decisions of the judges following their review are final and the judges will accept no further appeals beyond those decisions. The judges may contact the CNCCC to ensure that the proper deductions are made and for any additional guidance.

**The CNCCC will not consider any appeals beyond the Conference Competition, nor will it overturn any of the conference judges' decisions regarding the deductions assessed against a given team.**

The following sections detail the process of teams being informed of the deductions, the team captain's appeal (if they choose to do so), and the rendering of the final decision of the judges following their review of the appeal.

### 13.7.1 Design Paper

Following the scoring of the Design Paper, the judges shall come to a consensus of which deductions as listed on the *Design Paper Deduction Score Card* (Appendix A-7), if any, shall be assessed against a team. On the first day of the competition, the Head Judge or CNCCC member shall provide the team captains a copy of the *Design Paper Deduction Score Card* indicating which deductions, including their point value, are being applied and a *Request for Clarification and Appeals Form* (Appendix B-4 or B-5).

If the team chooses to appeal the deductions, the team captains will have until the date/time specified to submit to the Head Judge or CNCCC member the completed *Design Paper Deduction Score Card* (with signature), *Request for Clarification and Appeals Form* and any supporting documentation. The judges shall review the appeal, render their final decision, and inform the team captains of the decision prior to the completion of the day's events or the Awards Presentation, whichever comes first. Upon being informed of the judges' decision, no further appeal may be filed.

### 13.7.2 Final Product

#### 13.7.2.1 Aesthetics Judging

Immediately following the aesthetics judging of the team's Final Product, the judges shall come to a consensus of which standardized deductions as listed on the *Final Product Deduction Score Card* (Appendix A-8), if any, shall be assessed against a team. The head judge or CNCCC member shall immediately provide the team captains a *Final Product Deduction Score Card* indicating which deductions, including their point value, are being applied and a *Request for Clarification and Appeals Form* (Appendix B-4 or B-5).

If the team chooses to appeal the deductions, the team captains will have until the date/time specified to submit to the Head Judge or CNCCC member the completed *Final Product Deduction Score Card* (with signature), *Request for Clarification and Appeals Form* and any supporting documentation. The judges shall review the appeal, render their final decision, and inform the team captains of the decision prior to the completion of the day's events or the Awards Presentation, whichever comes first. Upon being informed of the judges' decision, no further appeal may be filed.

### 13.7.2.2 Durability

Following the completion of the endurance races and the preliminary sprint races, all of the canoes shall be removed from the water, assembled in a common place, and inspected by the judges and/or CNCCC members for the usage of tape as a repair material. Team captains shall be present with their canoes at the time of inspection and shall have with them any *Damage/Accident Report* (Appendix B-3) including written permission for any tape that is applied to the canoe. Any tape that is applied to the canoe, without written permission, is subject to deduction. Tape used to secure gunwale protective caps/coverings and tape used to secure additional flotation material in order to pass the flotation test does not apply in this instance. The team captain shall be informed verbally if a point deduction is being assessed. The decision of the judges and/or CNCCC members is final and is not subject to appeal.

## 13.7.3 Race Events

### 13.7.3.1 Endurance

If any penalties (Section 11.4) have been assessed against a team during the endurance race, the head judge or CNCCC member shall immediately inform the team captain of the infraction and its deduction at the completion of the team's race. The team captains may lodge a verbal appeal before the next three (3) canoes finish the race. Following the review of the appeal, the decision of the judges and CNCCC concerning all aspects of the race shall be final.

### 13.7.3.2 Sprints

If any penalties (Section 11.4) have been assessed against a team during the sprint race, the head judge or CNCCC member shall immediately inform the team captain of the infraction and its deduction at the completion of the team's heat. The team captains may lodge a verbal appeal before the start of the next heat. Following the review of the appeal, the decision of the judges and CNCCC concerning all aspects of the race shall be final.



<b>Design Paper</b>		<b>25% of Overall Score</b>	
<b>School Name:</b> _____	<b>Possible Points</b>	<b>Score (whole numbers)</b>	
<b>Canoe Name:</b> _____			
<b>Project and Quality Management</b> (per Section 6.2.2.d.) PM Application (effectively understands and communicates CPM) (15 points) Project Schedule - Completeness (per Section 6.2.2.i.) (5 points) Organization Chart - Completeness (per Section 6.2.2.e.) (5 points) Discussion of overall QA/QC program for the entire project (10 points)	<b>35</b>		
<b>Hull Design and Structural Analysis</b> (per Section 6.2.2.f.) Discussion of hull design and reasoning for design choices (10 points) Modeling (appropriateness of loading cases, applied loads, support conditions, model geometry) (5 points) Conclusions (appropriateness, validity, and importance of goal properties selected) (10 points)	<b>25</b>		
<b>Development and Testing</b> (per Section 6.2.2.g.) Testing program (tests used for individual materials and composite action and execution and validity of those tests) (10 points) Development (understands relationship between mix component properties and proportions and achieving design goal based on analysis) (10 points) Conclusions (appropriateness, validity, and importance of test results achieved) (10 points) Sustainability (5 points)	<b>35</b>		
<b>Construction</b> (per Section 6.2.2.h.) Construction Application (construction process and techniques, QA/QC, finishing/aesthetics) (15 points) Construction Drawing - Clarity (ease of understanding the drawing) and completeness (per Section 6.2.2.j.) (5 points) Sustainability (5 points)	<b>25</b>		
<b>Appendix B – Mixture Proportions</b> Completeness of Mixture Design Tables (5 points) Thoroughness of calculation & Correct Math (15 points)	<b>20</b>		
<b>Appendix C – Sample Structural Calculation</b> Thoroughness of calculation & Correct Math (20 points)	<b>20</b>		
<b>Appendix D – Hull Thickness/Reinforcement and Percent Open Area</b> Thoroughness of calculation & Correct Math (5 points)	<b>5</b>		
<b>Innovation</b> Incorporation of new, innovative ideas and concepts in the development of the canoe design, concrete mixture, construction, etc. (15 points)	<b>15</b>		
<b>Overall Presentation</b> Effective Use of Graphics, Tables, Charts & Quality of Writing (10 points) Conciseness and Clarity (10 points)	<b>20</b>		
<b>Subtotal</b>	<b>200</b>		
<b>Academic Judging - Design Paper Total</b>			

<b>Oral Presentation</b>		<b>25% of Overall Score</b>	
<b>School Name:</b> _____	<b>Possible Points</b>	<b>Score (whole numbers)</b>	
<b>Canoe Name:</b> _____			
<b>Presenters</b> Preparation Level (10 points) Confidence/Voice Projection (6 points) Overall Demeanor (4 points)	<b>20</b>		
<b>Presentation</b> Quality of Audio/Visuals (10 points) Content (20 points) Professionalism (10 points)	<b>40</b>		
<b>Judges' Questions</b> Preparation/Expertise in Answers (20 points) Confidence Level (10 points) Conciseness of Answers (10 points)	<b>40</b>		
<b>Comments:</b>			
<b>Subtotal</b>	<b>100</b>		
<b>Deductions:</b> Failure to observe time limit: A 15-point penalty shall be assessed when the official time exceeds 5 minutes 5 seconds (5:05). An additional 15-point deduction shall be assessed for exceeding each additional minute or fraction thereof on the official timer's clock, i.e., 6:00, 7:00, etc. (Section 8.3).			
Failure to have at least 2 presenters: 15 points			
Sponsorship or commercialism violation: 15 points			
Failure to adhere to live presentation format: No Oral Presentation Points			
<b>Academic Judging - Oral Presentation Total</b>			

# FINAL PRODUCT AESTHETICS SCORE CARD

Evaluation Sheet from Judge: \_\_\_\_\_

Refer to Sections 9.1.2 and 9.1.3 and the following page regarding judging criteria and scoring. Enter a numeric value (whole numbers) in category and tally the total score.

	Name of School	Canoe Workmanship (0 to 30 Points,)	Exterior and Interior Finish (0 to 30 Points)	Cross- Section Workmanship (0 to 20 Points)	Product Display (0 to 20 Points)	Total (100 pts. max)
1						
2						
3						
4						
5						
6						
7						
8						
9						
10						
11						
12						
13						
14						
15						
16						
17						
18						
19						
20						
21						
22						
23						
24						
25						

## FINAL PRODUCT AESTHETICS

Below are a list of descriptions, guidelines, and things to consider while judging the Final Product Aesthetics. Note that these are not to be thought of as an “all-inclusive list.” Ultimately, it is up to each individual judge to provide a score for each category and provide consistent scoring from school to school.

**Canoe Workmanship** – The intent of Canoe Workmanship is to evaluate the build quality of a canoe and the ability to withstand the rigors of transportation and racing. Most items in this category are related to the construction of the canoe itself. While conducting the durability check during races, consider how well the canoe has withstood the races and if needed, consider revising the Canoe Workmanship score accordingly. Some things to consider include, but are not limited to:

- are there noticeable cold joints in the concrete;
- the “lumpiness” of the concrete;
- the consistency of the wall thickness;
- the consistency of concrete color(s);
- the consistency of concrete materials (i.e. are there clumps of fibers visible, are there other areas the concrete was clearly not mixed well, etc.);
- is there is any cracking or micro-cracking;
- is any reinforcement mesh visible;
- if there is any concrete chipped off (either due to poor construction or mishandling of the finished canoe);
- are there any other general quality control issues

**Exterior and Interior Finish** – The intent of the Exterior and Interior Finish is to mostly evaluate the post-construction processes and general aesthetics. Some things to consider include, but are not limited to:

- the smoothness of the finish;
- if there are noticeable voids/ “bug holes” in the concrete;
- the intricacy of graphics;
- how ‘clean’ the edges of the graphics are;
- the execution of various techniques used for creating the aesthetics (i.e. colored concrete, sand blasting, 3-D elements, etc.);
- evaluation of the overall theme and how it fits with the aesthetics/graphics

**Cross-Section Workmanship** – The intent of the Cross-Section Workmanship is to evaluate how well the cross-section represents all the processes and materials used to fabricate the canoe. Some things to consider include, but are not limited to:

- is the cross-section full scale and a minimum of 3 feet of concrete shown (the mold should be included, but the mold does not count towards 3 feet);
- is the cross-section representative of the construction process actually used;
- are all the layers of concrete shown and demonstrate the concrete casting process;
- are all the materials used shown (i.e. reinforcement, mold, graphics application, sealer, etc);
- are all the processes clearly labeled;
- if applicable, are there any components highlighting new or innovative processes;
- is the entire process from start to finish easy to follow

*Continued on next page...*

**Product Display** – The intent of the Product Display is to evaluate how creatively and effectively the table top display showcases the overall “big picture” of the entire canoe/cross-section/table display setup while incorporating all the required display items. Some things to consider include, but are not limited to:

- how the table top display is organized and is it easy to find various components;
- are all the required sample items present and of proper size;
- are the items labeled and easy to read;
- is the bill of materials presented and is it complete and organized;
- is the safety analysis sheet completed properly;
- is the information related to QA/QC and project management complete, organized, and easy to follow;
- if applicable, are there any components highlighting new or innovative processes;
- if there are more than the required items on the table top display, do they help to provide insight to various tests or research performed during the project;
- are the table top display, cross-section, and canoe stands effectively integrating the canoe theme

## INSTRUCTIONS - DEDUCTION SCORE CARDS

### Instructions:

1. The Conference/National Judges shall come to a consensus on the determination of any infractions made by the team regarding the competition event (i.e., Design Paper and Final Product.).
2. Judges shall circle the point value of the deduction in the “Deduction” column. The points of the deductions for the infractions are standardized (i.e., cannot be higher or lower than what is prescribed).
3. The Head Judge shall tally the deductions and initial his/her name next to it. At the National Competition, a CNCCC member may tally the deductions in lieu of the Head Judge; however, the judges will make the determination of the infractions.
4. The total amount of deductions can exceed 100 points.
5. The Head Judge (or CNCCC member) shall provide all team captains with these forms to inform them of the deductions being assessed against them. Teams with no deductions will also be provided with these forms to assure anonymity.
6. The team captains shall indicate if they agree with the infractions and deductions or if they wish to appeal any of the infractions by signing the form. Teams that wish to appeal the infractions shall be given a reasonable amount of time to review the rules, obtain their supportive documentation, and provide the judges with their response. Teams are strongly cautioned to be able to substantiate their appeals.
7. The Head Judge (or CNCCC member) shall indicate the day and time (deadline) that the team captains have to submit the completed and signed form to the judges or CNCCC member.
8. Following the receipt of the form, the judges shall re-evaluate any infractions that the teams may appeal given the supportive documentation that they provide, and render their final decision on the form. The Head Judge shall input the official total deduction, sign off on the form, and inform the team captains of the judges’ decision. Once this is done, no further appeals regarding this matter will be entertained.
9. All appeals shall be handled prior to the Awards Ceremony. The final tally shall be inputted on the paper copy of the score sheet and in the electronic score sheet which is then officially ratified by the Head Judge. At the National Competition, the Head Judge and the CNCCC will ratify the scores.
10. Members of the CNCCC will either be on-call (during conference competitions) or on-site (during the national competition) and are available to provide guidance, clarification, and interpretation of the rules and regulations for the judges. During the competitions, teams are given the option to request that the judges contact the CNCCC for rule interpretation (see Request for Clarifications and Appeals).

# DESIGN PAPER DEDUCTION SCORE CARD

School: \_\_\_\_\_

**Infraction**

**Deduction**

*(Circle those that apply)*

A. Use of plagiarized material	No Design Paper Points
B. Failure to follow format, page and/or body text requirements	15 Points
C. Design Paper over specified number of pages ( ____ page) x 10 Pts/page	____ Points
D. Design Paper or <i>Project Overview and Technical Addendum</i> received after deadline ( _ days) x5 Pts/day	____ Points
E. Missing Table of Contents and/or Executive Summary	10 Points
F. Missing Project and Quality Management Section	10 Points
G. Missing Organizational Chart	10 Points
H. Missing Hull Design and Structural Analysis Section	10 Points
I. Missing Development and Testing Section	10 Points
J. Missing Construction Section	10 Points
K. Missing Construction Drawing	10 Points
L. Missing Project Schedule	10 Points
M. Missing Appendix A – References	20 Points
N. Incomplete Appendix A – References	10 Points
O. Missing Appendix B – Mixture Proportions and Calculations	20 Points
P. Incomplete Appendix B – Mixture Proportions and Calculations	10 Points
Q. Missing Appendix C – Example Structural Calculations (includes use of incorrect loading scenario)	20 Points
R. Incomplete Appendix C – Example Structural Calculations	10 Points
S. Missing Appendix D – Hull Thickness and Percent Open Area	20 Points
T. Incomplete Appendix D – Hull Thickness and Percent Open Area	10 Points
U. Failure to add <i>Repair Report</i> or <i>Reconstruction Request</i> as Appendix E <i>(Only applicable at the National Competition)</i>	20 Points
V. Failure to submit a <i>Preliminary Project Schedule</i> by deadline <i>(Only applicable at the National Competition)</i>	10 Points

**Total Deductions (Design Paper)** \_\_\_\_\_ Points

Please provide information on the infraction(s) being applied:

\_\_\_\_\_

\_\_\_\_\_

\_\_\_\_\_

\_\_\_\_\_

\_\_\_\_\_

\_\_\_\_\_

**REVIEW REVERSE SIDE**

Teams shall have until (day/time) \_\_\_\_\_ to either agree with the judges' deductions for the infractions listed above or to appeal the decision and provide supportive documentation.

---

**FOR TEAM CAPTAINS ONLY**

- We agree with the infractions and deductions applied to the Design Paper
- We wish to appeal the following infractions (*circle those that apply*):

A B C D E F G H I J K L M N O P Q R S T U V

---

**Team Captain**

---

**Team Captain**

---

**FOR COMPETITION OFFICIAL USE ONLY**

Upon review of the Appeal Form (and any supportive documentation) provided by the team captain:

- The deductions originally determined by the judges shall stand.
- The deductions for the following infractions shall be rescinded (*circle those that apply*):

A B C D E F G H I J K L M N O P Q R S T U V

The total deduction for the Design Paper is \_\_\_\_\_ Points.

\_\_\_\_\_ **Head Judge**



# FINAL PRODUCT DEDUCTION SCORE CARD

## CONFERENCE COMPETITION

School: \_\_\_\_\_

<b>Infraction</b>	<b>Deduction</b>
	<i>(Circle those that apply)</i>
A. Canoe not built within current academic year; cannot race due to design or safety issues, or cannot complete preliminary sprint and endurance events	No Final Product Points
B. Reinforcement thickness exceeds 50% of canoe thickness	No Final Product Points
C. Use of Bondo®, epoxy, or similar materials for construction or repairs	No Final Product Points
D. Use of more than 3 concrete mixtures	No Final Product Points
E. Non-compliant or non-approved cementitious materials ( <i>MTDS should show compliance</i> )	15 Points
F. Non-compliant aggregate proportioning (ASTM C330 Volume)	25 Points
G. Non-compliant aggregate proportioning (Total Aggregate Volume)	25 Points
H. Non-compliant or non-approved admixtures ( <i>MTDS should show compliance</i> )	15 Points
I. Improper or non-compliant finishing (sealer, use of stain or paint, use of glitter. etc.)	20 Points
J. Canoe does not meet dimensional constraints (length and/or width)	20 Points
K. Reinforcement does meet required Percent Open Area	10 Points
L. Flotation not within 3 feet of Bow and/or Stern (prior to flotation test at Conference Competition)	10 Points
M. Flotation not encased in concrete (prior to flotation test at Conference Competition)	10 Points
N. Non-compliant lettering height	5 Points
O. Missing/Incomplete items from the Final Product Display:	
Hard Copy of <i>Project Overview and Technical Addendum</i>	5 Points
Hard Copy of Design Paper	5 Points
Sample(s) of concrete cylinders ( ____ items) x 5 Pts/item	____ Points
Sample(s) of aggregate (individual and/or composite) ( ____ items) x 5 Pts/item	____ Points
Sample(s) of reinforcement (mesh, grid, strands, tendons, bars and/or fibers) ( ____ items) x 5 Pts/item	____ Points
Bill of Materials and/or Safety Analysis	5 Points
Project Management and QA/QC Info	5 Points
P. Cross-section not meeting specifications (size) and/or does not properly represent the canoe and/or use of additional photographs on cross section	20 Points
Q. Missing, Incomplete, or Incorrect Items in the <i>Project Overview and Technical Addendum</i>	
Certificate of Compliance	5 Points
“How To”	5 Points
Material Technical Data Sheets ( ____ items) x 5 Pts/item	____ Points
<b>Flotation Test:</b> PASS / FAIL	25 points
<b>Durability:</b> NO TAPE / TAPE (if TAPE is needed for durability-related issues)	25 points

**Total Deductions (Final Product)** \_\_\_\_\_ Points

**REVIEW REVERSE SIDE**

Please provide information on the infraction(s) being applied:

---

---

---

---

---

---

---

---

Teams shall have until (day/time) \_\_\_\_\_ to either agree with the judges' deductions for the infractions listed above or to appeal the decision and provide supportive documentation.

---

**FOR TEAM CAPTAINS ONLY**

- We agree with the infractions and deductions applied to the Final Product
- We wish to appeal the following infractions *(circle those that apply)*:

A B C D E F G H I J K L M N O P Q R

---

**Team Captain**

---

**Team Captain**

---

**FOR COMPETITION OFFICIAL USE ONLY**

Upon review of the Appeal Form (and any supportive documentation) provided by the team captain:

- The deductions originally determined by the judges shall stand.
- The deductions for the following infractions shall be rescinded *(circle those that apply)*:

A B C D E F G H I J K L M N O P Q R

The total deduction for the Final Product is \_\_\_\_\_ Points.

---

**Head Judge**

# FINAL PRODUCT DEDUCTION SCORE CARD

## NATIONAL COMPETITION

School: \_\_\_\_\_

<b>Infraction</b>	<b>Deduction</b>
	<i>(Circle those that apply)</i>
A. Canoe not built within current academic year; cannot race due to design or safety issues, or cannot complete preliminary sprint and endurance events	No Final Product Points
B. Reinforcement thickness exceeds 50% of canoe thickness	No Final Product Points
C. Use of Bondo®, epoxy, or similar materials for construction or repairs	No Final Product Points
D. Use of more than 3 concrete mixtures	No Final Product Points
E. Non-compliant or non-approved cementitious materials (MTDS should show compliance)	15 Points
F. Non-compliant aggregate proportioning (ASTM C330 Volume)	25 Points
G. Non-compliant aggregate proportioning (Total Aggregate Volume)	25 Points
H. Non-compliant or non-approved admixtures ( <i>MTDS should show compliance</i> )	15 Points
I. Improper or non-compliant finishing (sealer, use of stain or paint, use of glitter. etc.)	20 Points
J. Canoe does not meet dimensional constraints (length and/or width)	20 Points
K. Reinforcement does not meet required Percent Open Area	10 Points
L. Flotation not within 3 feet of Bow and/or Stern (prior to flotation test at Conference Competition)	10 Points
M. Flotation not encased in concrete (prior to flotation test at Conference Competition)	10 Points
N. Non-compliant lettering height	5 Points
O. Missing/Incomplete items from the Final Product Display:	
Hard Copy of <i>Project Overview and Technical Addendum</i>	5 Points
Hard Copy of Design Paper	5 Points
Sample(s) of concrete cylinders ( ____ items) x 5 Pts/item	____ Points
Sample(s) of aggregate (individual and/or composite) ( ____ items) x 5 Pts/item	____ Points
Sample(s) of reinforcement (mesh, grid, strands, tendons, bars and/or fibers) ( ____ items) x 5 Pts/item	____ Points
Bill of Materials and/or Safety Analysis	5 Points
Project Management and QA/QC Info	5 Points
P. Cross-section not meeting specifications (size) and/or does not properly represent the canoe and/or use of additional photographs on cross section	20 Points
Q. Missing, Incomplete, or Incorrect Items in the <i>Project Overview and Technical Addendum</i>	
Certificate of Compliance	5 Points
“How To”	5 Point
Material Technical Data Sheets ( ____ items) x 5 Pts/item	____ Points
R. Reported concrete oven dry unit weight not within $\pm 5$ lb/ft <sup>3</sup> of measured unit weight	10 Points
S. Reported weight of canoe not within $\pm 10$ lbs. of the measured weight	10 Points
T. School granted permission to repair /reconstruct canoe	25 / 50 points
<b>Flotation Test:</b> PASS / FAIL	25 points
<b>Durability:</b> NO TAPE / TAPE (if TAPE is needed for durability-related issues)	25 points

**Total Deductions (Final Product)** \_\_\_\_\_ Points

**REVIEW REVERSE SIDE**

Please provide information on the infraction(s) being applied:

---

---

---

---

---

---

---

---

Teams shall have until (day/time) \_\_\_\_\_ to either agree with the judges' deductions for the infractions listed above or to appeal the decision and provide supportive documentation.

---

**FOR TEAM CAPTAINS ONLY**

- We agree with the infractions and deductions applied to the Final Product
- We wish to appeal the following infractions *(circle those that apply)*:

A B C D E F G H I J K L M N O P Q R S T

---

**Team Captain**

---

**Team Captain**

---

**FOR COMPETITION OFFICIAL USE ONLY**

Upon review of the Appeal Form (and any supportive documentation) provided by the team captain:

- The deductions originally determined by the judges shall stand.
- The deductions for the following infractions shall be rescinded *(circle those that apply)*:

A B C D E F G H I J K L M N O P Q R S T

The total deduction for the Final Product is \_\_\_\_\_ Points.

---

**Head Judge**

# REPAIR PROCEDURE REPORT

**School Name:**

**Canoe Name:**

**Team Captain(s):**

**Date of Request:**

**Description of Cause:**

**Description of Repair:**

**Materials used in Repair:**

**Description of Supporting Documentation:**

*Provide a list of Supporting Documentation attached to this report*

<b>CNCCC Disposition</b>		
<b>Date:</b>		
<b>Request to Repair Canoe:</b>	<input type="checkbox"/> <b>Granted</b>	<input type="checkbox"/> <b>Declined</b>
<b>Reason for Disposition:</b>		

*This report, CNCCC disposition, and supporting documentation shall be included in Appendix D of the Design Paper. Failure to do so will result in a 25-point deduction from the Design Paper final score.*

*Filing this report does not guarantee the school will be granted permission to conduct repairs to their canoe. The ability to do so is a function of the reason for the request and the supporting documentation. Under no circumstances should a school consider a verbal disposition permission to repair their canoe.*

*If the school is permitted to conduct repairs, that school will receive a 25-point penalty for doing so. The maximum final product points will be reduced to 75 out of 100 points. This penalty may be waived at the discretion of the CNCCC on a case by case basis.*

# RECONSTRUCTION REQUEST

**School Name:**

**Canoe Name:**

**Team Captain(s):**

**Date of Request:**

**Reason for Request:**

**Description of Supporting Documentation:**

*Provide a list of Supporting Documentation attached to this report*

<b>CNCCC Disposition</b>		
<b>Date:</b>		
<b>Reconstruction Request:</b>	<input type="checkbox"/> <b>Granted</b>	<input type="checkbox"/> <b>Declined</b>
<b>Reason for Disposition:</b>		

*This request, CNCCC disposition, and supporting documentation shall be included in Appendix D of the Design Paper. Failure to do so will result in a 25-point deduction from the Design Paper final score.*

*Filing this report does not guarantee the school listed above will be granted a Reconstruction Request. The ability to do so is a function of the reason for the request and the supporting documentation. Under no circumstances should a school consider a verbal disposition permission to rebuild their canoe.*

*If the school is permitted to reconstruct, that school will receive a 50-point penalty for doing so. The maximum final product points will be reduced to 50 out of 100 points. This penalty may be waived at the discretion of the CNCCC on a case by case basis.*

# DAMAGE / ACCIDENT REPORT

**School Name:**

**Canoe Name:**

**Date of Accident:**

**Location of Accident:**

**Type of Accident:**

- Collision with other canoe       Paddler fell out of canoe  
 Collision with inanimate object       Other: \_\_\_\_\_

**Briefly Describe Circumstances of Accident:**

**Describe in Detail the Extent of Damage:**

**Team Captain's Signature:** \_\_\_\_\_

**Team Captain's Signature:** \_\_\_\_\_

---

**FOR COMPETITION OFFICIAL USE ONLY**

**Damage is due to accident outside the control of the paddlers? (Circle one)**      YES      NO

**Comments:**

Deduct 25 points from Final Product \_\_\_\_\_ Do Not Deduct 25 Points from Final Product \_\_\_\_\_

---

**Head Judge**

# REQUEST FOR CLARIFICATIONS AND APPEALS

## CONFERENCE COMPETITIONS

**Instructions:** Completed forms must be submitted immediately by the Team Captain to the Conference Concrete Canoe Competition Head Judge. Requests for clarification and appeals will not be considered once the competition has concluded. All decisions of the judges are final.

**School Name:**

**Team Captain(s):**

**Nature of Inquiry:**

- ( ) Design Paper
- ( ) Oral Presentation
- ( ) Final Product
- ( ) Races
- ( ) Other: \_\_\_\_\_

**Briefly Describe Nature of Inquiry or Appeal:** (Continue on reverse side if more space is needed).

*We formally request that the CNCCC member on-call be contacted in order to obtain an official interpretation or clarification regarding this matter.*

**Rules & Regulations Section(s) Referenced:**

**Team Captain's Signature:** \_\_\_\_\_

**Team Captain's Signature:** \_\_\_\_\_



# REQUEST FOR CLARIFICATIONS AND APPEALS

## ASCE NATIONAL COMPETITION

*Instructions: Completed forms must be submitted immediately by the Team Captain to the Conference Concrete Canoe Competition Head Judge. Requests for clarification and appeals will not be considered once the competition has concluded. All decisions of the judges are final.*

**School Name:**

**Team Captain(s):**

**Nature of Inquiry:**

- Design Paper
- Oral Presentation
- Final Product
- Races
- Other: \_\_\_\_\_

**Briefly Describe Nature of Inquiry or Appeal: (Continue on reverse side if more space is needed).**

**Rules & Regulations Section(s) Referenced:**

**Team Captain's Signature:** \_\_\_\_\_

**Team Captain's Signature:** \_\_\_\_\_

## Appendix C – General Guidelines for Concrete Mixture Data Table

### References

Section 3 – CONCRETE	2018 ASCE NCCC Rules and Regulations
ASTM C127	Standard Test Method for Relative Density (Specific Gravity) and Absorption of Coarse Aggregate
ASTM C128	Standard Test Method for Density, Relative Density (Specific Gravity), and Absorption of Fine Aggregates
ASTM C138/C138 M	Standard Test Method for Density (Unit Weight), Yield and Air Content (Gravimetric) of Concrete
ASTM C330	Standard Specification for Lightweight Aggregates for Structural Concrete

This appendix provides general guidelines and helpful hints so that teams understand what is required in the table and how it should be properly filled out.

### General Comments:

- Under the categories of “Cementitious Materials,” “Aggregates,” “Fibers,” and “Admixtures”, provide the name of the constituents that are being used. **Commercial (trade) names should be used if it is clear what the product is,**
- Absorption and moisture content values (in percent) for the aggregates shall be provided (to the nearest 0.1%)
- Under the “Specific Gravity” column, provide the specific gravity (dimensionless) of the cementitious materials, aggregates, fibers, and water used in the concrete mix. **For aggregates, you will provide the Oven Dried (OD) and Saturated, Surface Dry (SSD) values.** Two or three decimal places are sufficient.
- The weight of the liquid admixtures shall be provided in lb/gal.

### Notes:

1. The values provided in these tables are shown for MATHEMATICAL EXAMPLE purposes only.
2. Teams should not consider the mixture proportions shown to result in concrete with the needed fresh (slump, air content) and hardened (strength) characteristics required for the competition.
3. Values such as specific gravity are based on generalized numbers and should not be used for your design calculations (i.e., do not reference this document as the one you based your values on).
4. Some numbers are rounded.

The following is a step-by-step example for reporting the FINAL yielded concrete mixture proportions and checks to make sure that it is theoretically and mathematically correct. **This means that the reported unit weight is measured and the values provided consider relative yield.**

Type I/II Cement                    370 lb, SG = 3.15  
 Fly Ash (Class C)                    350 lb, SG = 2.75  
 Blast Furnace Slag                    110 lb, SG = 2.55

Fibers, Nylon                            6.5 lb, SG = 1.4

w/cm ratio                                0.43

Aggregate	SG <sub>SSD</sub>	W <sub>OD</sub> (lb)	W <sub>SSD</sub> (lb)	W <sub>stk</sub> (lb)	Abs (%)	MC <sub>stk</sub> (%)
A	0.45	120.0	144.00	135.6		13.0
B (meets C330)	0.90	215.0			8.0	12.0
C	1.00	110.0	115.50	115.50	5.0	5.0

Admixtures:                                6 fl oz/cwt HRWR Admixture (47% solids by weight, 8.5 lb/gal)  
     250 fl oz/cwt Latex (68% solids by weight, 8.8 lb/gal)  
     20 fl oz/cwt Liquid Dye (50% solids by weight, 10.0 lb/gal)

Measured Unit Weight (wet) 64.24 lb/ft<sup>3</sup>

### ABSOLUTE VOLUME METHOD

The absolute volume of a given material is computed by dividing the mass of the material by its absolute density, which is the specific gravity (SG) times the density of water (62.4 lb/ft<sup>3</sup>), as shown by:

$$\text{Absolute Volume} = \text{mass} / (\text{SG} \times 62.4)$$

Example :      How much volume does 370 lbs of portland cement occupy given that SG = 3.15?

$$\begin{aligned} \text{Volume}_{\text{cement}} &= \text{Mass}_{\text{cement}} / (\text{SG}_{(\text{cement})} \times 62.4) \\ &= 370 / (3.15 \times 62.4) = 1.882 \text{ ft}^3 \end{aligned}$$

In a batch of concrete, the sum of the absolute volumes of cementitious materials, aggregate, fibers, water, solids from admixtures and air, gives the volume of concrete produced per batch.

The above equation can be used to determine the volumes of the various constituents and populate the table.

**When the volume of aggregate is computed, the oven-dried (OD) amount and specific gravity are used together, or the saturated, surface dry (SSD) amount and specific gravity are used together. Numerically, you will obtain the same value.**

## AGGREGATES

In this example, there are three (3) aggregate sources being used. To complete the table, you will need to know the specific gravity, weights (amounts), absorption. This information will eventually be of use in determining the proper batching of water:

Aggregate	SG <sub>SSD</sub>	W <sub>OD</sub> (lb)	W <sub>SSD</sub> (lb)	W <sub>stk</sub> (lb)	Abs (%)	MC <sub>stk</sub> (%)
A	0.45	120.0	144.00	135.6		13.0
B (meets C330)	0.90	215.0			8.0	12.0
C	1.00	110.0	115.50	115.50	5.0	5.0

For Aggregate A, the absorption of the aggregate can be found using the oven-dried and saturated, surface dry (SSD) weights in the following equation:

$$Abs = \frac{W_{ssd} - W_{od}}{W_{od}} \times 100\%$$

$$= (144 \text{ lb} - 120 \text{ lb}) / (120 \text{ lb}) \times 100\% = 20.0\%$$

For Aggregate B, the weight of the aggregate in the SSD condition and the stock moisture content, MC<sub>stk</sub>, can be found by using the following equation (note: for the stock condition, Abs is replaced with MC<sub>stk</sub>):

$$MC_{free} = MC_{total} - Abs$$

For W<sub>SSD</sub>

$$= [1 + (8/100)] \times 215 = 232.2 \text{ lb}$$

For W<sub>stk</sub>

$$= [1 + (12/100)] \times 215 = 240.8 \text{ lb}$$

The table can now be completed as shown below

Aggregate	SG <sub>SSD</sub>	W <sub>OD</sub> (lb)	W <sub>SSD</sub> (lb)	W <sub>stk</sub> (lb)	Abs (%)	MC <sub>stk</sub> (%)
A	0.45	120.0	144.00	135.60	20.0	13.0
B (meets C330)	0.90	215.0	232.20	240.80	8.0	12.0
C	1.00	110.0	115.50	115.50	5.0	5.0

Please note the moisture conditions of the three aggregates:

- Aggregate A has a stock moisture content of 13% with absorption of 20% (*this means that it will soak up water as it is drier than the SSD condition*).
- Aggregate B is the opposite, as the stock moisture content is higher than the SSD condition (*this means it has excess or “free” water*).
- Aggregate C is currently in the SSD condition in the stockpile.

## WATER

Based on the final w/cm ratio, the amount of water is simply computed using the total amount of cementitious material in the mixture

$$Water = w/cm \times cm$$

Example: How much water is needed for 830 lbs of cm using a w/cm of 0.43?

$$Water = w/cm \times cm$$

$$Water = 0.43 \times 830 \text{ lb} = 356.9 \text{ lb}$$

The water that is computed from the w/cm ratio is the water that is needed to hydrate the cementitious materials (cm). It is not used to condition the aggregate to the SSD condition.

The water (w) comes from three sources – water from the aggregate (if there is “free” water then the value of this is positive; if the aggregate is drier than the SSD condition, then the value is negative), water from the admixtures, and additional batch water, and is expressed as (or a rearrangement of this equation):

$$w_{batch} = w - (w_{free} + \sum w_{adm})$$

### Compute Free Water from Aggregates

With the values previously obtained for the aggregates, the total moisture content, free moisture content and the amount of moisture available, can be computed for each aggregate using the following three equations:

$$MC_{total} = \frac{W_{stk} - W_{od}}{W_{od}} \times 100\%$$

$$MC_{free} = MC_{total} - A$$

$$w_{free} = W_{OD} \times \left( \frac{MC_{free}}{100\%} \right)$$

Aggregate	W <sub>OD</sub> (lb)	W <sub>SSD</sub> (lb)	Abs (%)	MC <sub>total</sub> (%)	MC <sub>free</sub> (%)	W <sub>free</sub> (lb)
A	120.0	144.00	20.0	13.0	-7.0	-8.4
B (meets C330)	215.0	232.20	8.0	12.0	4.0	8.6
C	110.0	115.50	5.0	5.0	0	0

Combined, the aggregates have 0.20 lb of free water

### Compute Water from Admixtures

The water in the various admixtures can be found from the following equation:

$$\text{Water in admixture} = \text{dosage} \times \text{cwt of cm} \times \text{water content} \times (1 \text{ gal}/128 \text{ fl oz}) \times (\text{lbs}/\text{gal of admixture})$$

#### From latex

$$[(250 \text{ fl oz}/\text{cwt}) \times (830 \text{ lb}/\text{yd}^3)/100] \times [(100\% - 68\% \text{ solids})/100] \times (1 \text{ gal}/128 \text{ fl oz}) \times (8.8 \text{ lb}/\text{gal}) = \underline{45.65 \text{ lb}}$$

#### From liquid dye

$$[20 \text{ fl oz}/\text{cwt} \times 8.30 \text{ cwt}] \times [(100\% - 50\% \text{ solids})/100] \times (1 \text{ gal}/128 \text{ fl oz}) \times (10 \text{ lb}/\text{gal}) = \underline{6.48 \text{ lb}}$$

#### From HRWR

$$[6 \text{ fl oz}/\text{cwt} \times 8.30 \text{ cwt}] \times [(100\% - 47\% \text{ solids})/100] \times (1 \text{ gal}/128 \text{ fl oz}) \times (8.5 \text{ lb}/\text{gal}) = \underline{1.75 \text{ lb}}$$

Total water from all the admixtures is then 53.9 lb.

### Compute Batch Water

We have computed water from two of the three sources – the aggregate and the admixtures. Based on this example, we ended up having some “free” water from the aggregate (that is, the combined stock was wetter than the combined SSD condition). This “free” water, albeit a very small amount in this case, is available to hydrate the cm.

Since we know the amount of water needed to hydrate the cm (356.9 lb) based on the w/cm ratio chosen, the batch water can be computed by:

$$\begin{aligned} w_{\text{batch}} &= w - (w_{\text{free}} + \sum w_{\text{adm}}) \\ &= 356.9 \text{ lbs} - (0.20 + 53.9) = 302.8 \text{ lb} \end{aligned}$$

The volume of water ( $SG_{\text{water}} = 1$ ) is then

$$\begin{aligned} \text{Volume}_{\text{water}} &= \text{Mass}_{\text{water}} / (62.4) \\ &= 356.9 / 62.4 = 5.720 \text{ ft}^3 \end{aligned}$$

**SOLIDS (from admixtures)**

Typically, the proportional volume of the solids included in the liquid admixture is so small in relation to the size of the batch that it can be neglected. The exclusion to this include latex admixtures and dyes (both liquid and in powder form) which can have a substantial volumes.

- **For the competition, only latex and dye solids (in the liquid medium) are to be accounted for.**
- **Disregard the contribution of solids from other admixtures.**
- If you have a powdered admixture (i.e., it is not in a liquid medium), then simply use the absolute volume method as previously shown.

The solids content can be computed in a fashion like the water content from admixtures

$$\text{Solids in admixture} = \text{dosage} \times \text{cwt of cm} \times \text{solid content} \times (1 \text{ gal}/128 \text{ fl oz}) \times (\text{lb}/\text{gal of admixture})$$

From latex

$$[(250 \text{ fl oz}/\text{cwt}) \times 8.3 \text{ cwt}] \times [(68\% \text{ solids})/100] \times (1 \text{ gal}/128 \text{ fl oz}) \times (8.8 \text{ lb}/\text{gal}) = \underline{97.0 \text{ lb}}$$

Based on the weight of the admixture (in lb/gal) and the percentages of water and solids within it, one can determine the SG of the solid particles (SG of water is taken as 1.0) as follows:

- If the latex is 32% water by weight, the weight of water is 2.82 lb (0.32 x 8.8 lb)
- The weight of the solids is 5.98 lb (in a gal of admixture).
- The volume of water is then (2.82 / 62.4) to obtain 0.04513 ft<sup>3</sup>.
- Solids volume is 0.08855 ft<sup>3</sup>. Note: 1 gal = 0.13368 ft<sup>3</sup>.
- The unit weight of solids is then 5.98 lb / 0.08855 ft<sup>3</sup> = 67.58 lb/ft<sup>3</sup> and therefore its SG is determined to be 1.085.

From liquid dye

$$[20 \text{ fl oz}/\text{cwt} \times 8.30 \text{ cwt}] \times [(50\% \text{ solids})/100] \times (1 \text{ gal}/128 \text{ fl oz}) \times (10 \text{ lb}/\text{gal}) = 6.48 \text{ lb}$$

The specific gravity of the dye solids can be shown to be 1.496 following the procedure used for the latex as above.

**DENSITIES, AIR CONTENT, SLUMP and RATIOS**

Now that all the amounts have been determined, the respective volumes can be computed so that theoretical densities and air content can be found.

**Mass of Concrete (M)** – The mass of concrete is the sum of all masses of the constituents in the mixture – cm, fiber, aggregate, water and admixture solids:

$$M = Amount_{cm} + Amount_{fibers} + Amount_{aggregate} + Amount_{water} + Amount_{solids}$$

$$M = 830.00 + 6.50 + 491.70 + 356.90 + 103.49 = \underline{1788.59 \text{ lb}}$$

**Absolute Volume of Concrete (V)** – The absolute volume of concrete is the sum of all the constituents in the mixture. This is based on zero air content. **This value has to be less than 27 ft<sup>3</sup> (1 yd<sup>3</sup>):**

$$V = Volume_{cm} + Volume_{fibers} + Volume_{aggregate} + Volume_{water} + Volume_{solids}$$

$$V = 4.613 + 0.074 + 11.114 + 5.720 + 1.505 = \underline{23.026 \text{ ft}^3}$$

**Theoretical Density (T)** – is the density of concrete with no air in it and is the mass of concrete (M) divided by the absolute volume of concrete (V):

$$T = M / V$$

$$T = 1788.59 \text{ lb} / 23.026 \text{ ft}^3 = 77.68 \text{ lb/ft}^3$$

**Measured Density (D)** – the density of concrete obtained from cylinders, cubes, etc. in the plastic (wet) state (i.e., immediately after casting). In this example, it was 66.24 lb/ft<sup>3</sup>

**Air Content** – The air content is computed by comparing the theoretical density (no air) to the measured density (D):

$$\text{Air content} = (T - D) / T \times 100$$

$$\text{Air content} = (77.68 - 66.24) / 77.68 \times 100 = 14.7\%$$

**The value of the air content should be checked using the absolute volume method (you should come up with the same answer. If you do not, then there is an error someplace).**

$$\text{Air content} = (27 - V) / 27 \times 100$$

$$\text{Air content} = (27 - 23.026) / 27 \times 100 = 14.7\% \text{ (check)}$$

**Note: If the measured density is higher than the theoretical density, the result would be a negative air content. This is not possible.**

**Cement-Cementitious Materials Ratio**

The c/cm ratio is a calculated value: 370 lb c / 830 lb cm = 0.45

**Water-Cementitious Materials Ratio**

The w/cm ratio is a calculated value: 356.90 lb / 830 lb cm = 0.43

**Slump** – measured value (in inches).



## AGGREGTE PROPORTIONING

**Aggregate - Concrete Ratio (Volumetric)** – Per Section 3.3.3.a, the aggregate(s) selected shall constitute a minimum of 25% of the total volume of any concrete mixture based on yielded proportions

$$\begin{aligned} \text{Aggregate Ratio (\%)} &= V_{\text{aggregate}} / 27 \times 100\% \\ &= (5.128 + 4.135 + 1.851) / 27 \times 100\% \\ &= (11.114 / 27) \times 100\% = \underline{41.1\% > 25\% \text{ (OK!)}} \end{aligned}$$

Please note that there are several specific gravities reported for aggregate, depending on the condition that they are in, such as dry ( $SG_{OD}$ ) and saturated, surface dry ( $SG_{SSD}$ ). **The values are different** as one is obviously in the dry state and the other considers the water that is required to bring the aggregate to the SSD condition, and it can be shown that it is a function of absorption. For example, it can be shown that for Aggregate A ( $SG_{SSD} = 0.45$ ;  $A = 20\%$ ), the  $SG_{OD}$  is 0.375.

The volume that the aggregate occupies between the conditions, however, can be shown to be the same. That is, the volume of aggregate in the OD condition determined by taking the amount of aggregate in the OD condition divided by  $SG_{OD}$  is equal to the volume of aggregate in the SSD condition as determined by taking the amount of aggregate in the SSD condition divided by  $SG_{SSD}$ .

$$\text{Amount}_{\text{aggregate(OD)}} / (SG_{OD} \times 62.4) = \text{Amount}_{\text{aggregate(SSD)}} / (SG_{SSD} \times 62.4) = \text{Volume}_{\text{aggregate}}$$

**ASTM C330 Aggregate Ratio (Volumetric)** – Per Section 3.3.3.b., a minimum of 25% of the total aggregate volume, per concrete mixture, must be an aggregate source other than manufactured microspheres and/or cenospheres, that must be compliant with ASTM C330.

In this example, Aggregate B is ASTM C330 compliant and is neither a microsphere or a cenosphere.

Volume of aggregate in the SSD is equal to the volume of aggregate in the OD state

$$\begin{aligned} V_{\text{ASTM C330}} &= \text{Volume}_{\text{Aggregate B}} / \text{Volume}_{\text{aggregate}} \\ V_{\text{ASTM C330}} &= 4.135 / 11.114 = \underline{37.2\% > 25\% \text{ (OK!)}} \end{aligned}$$

MIXTURE DESIGNATION: STRUCTURAL

CEMENTITIOUS MATERIALS							
Component	Specific Gravity	Volume (ft <sup>3</sup> )	Amount of CM (mass/volume) (lb/yd <sup>3</sup> )				
Cement, Type I/II (ASTM C 150)	3.15	1.882	370.0	Total Amount of cementitious materials 830 lb/yd <sup>3</sup> c/cm ratio 0.45			
Class C Fly Ash	2.75	2.040	350.0				
Blast Furnace Slag	2.55	0.691	110.0				
FIBERS							
Component	Specific Gravity	Volume (ft <sup>3</sup> )	Amount of Fibers (mass/volume) (lb/yd <sup>3</sup> )				
Fiber, Nylon	1.40	0.074	6.50	Total Amount of Fibers 6.50 lb/yd <sup>3</sup>			
AGGREGATES							
Aggregates	ASTM C330*	Abs (%)	SG <sub>0b</sub>	SG <sub>SSD</sub>	Base Quantity (lb/yd <sup>3</sup> )		Volume (ft <sup>3</sup> )
					OD	SSD	
Aggregate 1	N	20	0.375	0.450	120.0	144.0	5.128
Aggregate 2	Y	8	0.833	0.900	215.0	232.2	4.135
Aggregate 3	N	5	0.952	1.000	110.0	115.5	1.851
ADMIXTURES							
Admixture	lb/gal	Dosage (fl.oz/cwt)	% Solids	Amount of Water in Admixture (lb/yd <sup>3</sup> )			
Latex (if used)	8.8	250	68	Total Water from Admixtures, $\sum W_{adm}$ 53.89 lb/yd <sup>3</sup>			
Liquid Dye (if used)	10.0	20	50				
HRWR	8.5	6	47				
SOLIDS (LATEX, DYES AND POWDERED ADMIXTURES ONLY)							
Component	Specific Gravity	Volume (ft <sup>3</sup> )	Amount (mass/volume) (lb/yd <sup>3</sup> )				
Latex (if used)	1.083	1.436	97.01	Total Solids from Admixtures 103.49 lb/yd <sup>3</sup>			
Liquid Dye (if used)	1.496	0.069	6.48				
WATER							
	Amount (mass/volume) (lb/yd <sup>3</sup> )				Volume (ft <sup>3</sup> )		
Water, lb/yd <sup>3</sup>	w: 356.9				5.720		
Total Free Water from All Aggregates, lb/yd <sup>3</sup>	$\sum W_{free}$ : 0.2						
Total Water from All Admixtures, lb/yd <sup>3</sup>	$\sum W_{adm}$ : 53.89						
Batch Water, lb/yd <sup>3</sup>	W <sub>batch</sub> : 302.81						
DENSITIES, AIR CONTENT, RATIOS AND SLUMP							
	cm	fibers	aggregates	solids	water	Total	
Mass of Concrete, M, (lb)	830.00	6.50	491.70	103.49	356.90	$\sum M$ : 1788.59	
Absolute Volume of Concrete, V, (ft <sup>3</sup> )	4.613	0.074	11.114	1.505	5.720	$\sum V$ : 23.026	
Theoretical Density, T, ( $=\sum M / \sum V$ )	77.68 lb/ft <sup>3</sup>		Air Content [ $=(T - D) / T \times 100\%$ ]			14.7%	
Measured Density, D	66.24 lb/ft <sup>3</sup>		Slump, Slump flow			2.0 in.	
water/cement ratio, w/c:	0.963		water/cementitious material ratio, w/cm:			0.43	

\* Indicate if aggregate, other than manufactured glass microspheres and/or cenospheres, is compliant with ASTM C330

$= M / 27 = 1788.59 / 27$

$= M / V = 1788.59 / 23.026$

$= (27 - V) / 27 = (27 - 23.026) / 27$   
As a check

Must be less than 27.

## Appendix D – Job Hazard Analysis

### Activity Hazard Analysis / Crew Briefing

Date: \_\_\_\_\_

School: \_\_\_\_\_

Lead Person: \_\_\_\_\_

Involved Crew Members: \_\_\_\_\_

\_\_\_\_\_

Location of Task: \_\_\_\_\_

Task Description: \_\_\_\_\_

\_\_\_\_\_

1. What are the hazards associated with the job / task?

\_\_\_\_\_

2. What will be done to eliminate/control the above hazards?

\_\_\_\_\_

3. Have they been explained to the crew members? Yes No

4. Is there acceptable access / egress to the worksite? Tripping hazards removed / addressed? Yes

No

5. Is there adequate illumination for all work? Yes No

6. What weather conditions could affect safety performance of this task? \_\_\_\_\_

\_\_\_\_\_

7. Are trash receptacles available in the work area? Water and sanitation facilities located? Yes No

8. Are flammable / combustible materials stored, separated, inspected, labeled, and secured per

procedure? Yes No

9. User inspection is required on all tools, ladders, electrical cords, rigging, and safety equipment. Has

this been completed? Yes No

10. Personal Protective Equipment Required – fill in what type is being used for this activity.

Eye/Face – \_\_\_\_\_

Head/Ear – \_\_\_\_\_

Hand – \_\_\_\_\_

Respirator – \_\_\_\_\_

Other – \_\_\_\_\_

**POST TASK ASSIGNMENT**

Date: \_\_\_\_\_

Lead Person: \_\_\_\_\_

1. Was anyone injured or did an unplanned incident occur today? Yes No

If yes, explain: \_\_\_\_\_  
\_\_\_\_\_

2. Was it reported to Management/Safety? Yes No NA

If yes, state who you told & when they were told.

\_\_\_\_\_

3. What problems did you have with today's work assignment?

\_\_\_\_\_  
\_\_\_\_\_

4. What can we do tomorrow to improve safety / performance?

\_\_\_\_\_  
\_\_\_\_\_

5. Miscellaneous concerns:

\_\_\_\_\_